



Furniture Catalogue

VOL 16 2020

WORKSTATIONS - FURNITURE - SEATING - STORAGE - ACCESSORIES
WWW.EPICOFFICEFURNITURE.COM.AU

 **EPIC OFFICE**
furniture.com.au

3-10	Reception and Lounge
11-16	Deluxe Infinity
17-21	Infinity
22	Infinity Accessories
23-24	Softwiring
25-28	Screen
29-31	Span
32-35	Tables
36-40	Height Adjustable Solutions
41-43	Vibe
44-46	Worker
47-49	Manager
50-53	Mesh Chairs
54-55	Operator Chairs
56-58	Executive Chairs
59-63	Breakout, Visitor Chairs and Stools
64	Chair and Screen Upholstery
65-66	Presentation Range
67	Accessories
68-70	Steel Storage
71	Office Storage
72	Mobile Storage
73-75	Lockers and Accessories

Your product is delivered from distribution centres in Sydney, Melbourne, Brisbane and Perth, with a local customer service team in each location.

We not only deliver in these areas but also offer a full installation service.

Have a requirement for an office fitout?

Our in-house projects team can design any layout to your requirements.

We cannot guarantee colours shown in this catalogue are the exact true representation of product colours. Specifications subject to change.



URBAN RECEPTION COUNTER

Natural White with driftwood wrap around cowl feature panel, built in 3 drawer under-desk pedestal, CPU & storage cupboard with 2 x chrome cable entry hole covers.

URC NW/DW

Finish	Natural White
Width	2200mm
Depth	800mm
Height	1150mm
Counter Height	750mm
Warranty	5 Years



Natural White
White / Driftwood



MARQUEE RECEPTION COUNTER

Gloss White veneer with zebra veneer front columns, gloss white top, 2 x chrome cable entry hole covers with brush insulators, built in 3 drawer under-desk pedestal, CPU & storage cupboard.

MRC GW / ZB

Finish	Gloss White
Width	2400mm
Depth	835mm
Height	1150mm
Counter Height	750mm
Warranty	5 Years



Gloss White /
Zebra



FLOW RECEPTION COUNTER

Curved reception counter with glass feature on side and high reception hob for privacy.

NCT1160

Finish	Beech
Width	2400 x 1600mm
Depth	800mm
Height	1160mm
Counter Height	730mm
Warranty	5 Years



Beech



BLOOM VERTICAL GARDEN

Bring nature into the office with a vertical garden, available in black or white, with 8 x 150mm diameter round pots and 20kg of polished stones. **Plants not included.**

SRBVG BK · SRBVG WH

Finish	White or Black
Width	395mm
Depth	210mm
Height	1940mm
Weight	40kg
Warranty	5 Years



White
Black



MODULAR RECEPTION COUNTER

Create your ideal reception counter by choosing between the MOD1 Full Height and MOD2 Glass Top pieces, configured in any mix and match layout to suit your space.

MOD1NW · Full Height Module

Finish	Natural White
Width	1339mm
Depth	800mm
Height	1160mm
Counter Height	730mm
Warranty	5 Years

MOD2NW · Glass Top Module

Finish	Natural White
Width	1339mm
Depth	800mm
Height	935mm
Counter Height	730mm
Warranty	5 Years



RC1809 RECEPTION COUNTER

Natural White counter with black powdercoated perforated cowl and matching kickplate.

RC1809 NW

Finish	Natural White
Width	1800mm
Depth	900mm
Height	1170mm
Counter Height	750mm
Warranty	5 Years



Natural White /
Black Powdercoat



5-O RECEPTION COUNTER

Gloss white veneer all over reception counter with chrome trim detail on front panel 2 X chrome cable entry hole covers with brush insulators.

RC5-O GW

Finish	Gloss White
Width	2400mm
Depth	848mm
Height	1100mm
Counter Height	750mm
Warranty	5 Years



Gloss White



FLEXI LOUNGE EXAMPLE CONFIGURATIONS



925mm W x 940mm D x 710mm H

SINGLE SEAT AND BACK REST - FL1



1830mm W x 940mm D x 710mm H

TRIPLE SEAT AND BACK REST - FL2



925mm W x 1880mm D x 710mm H

SINGLE BACK TO BACK - FL3

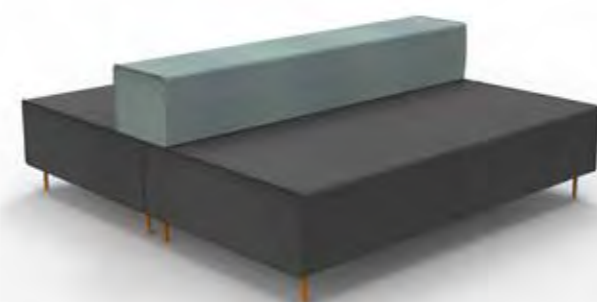

1830mm W x 1880mm D x 710mm H

TRIPLE BACK TO BACK - FL4

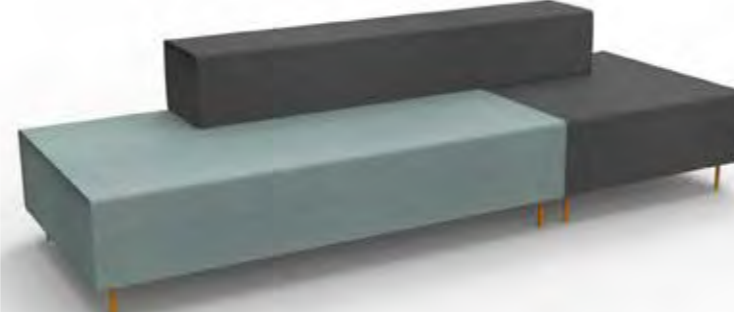

2755mm W x 940mm D x 710mm H

STRETCH - FL5

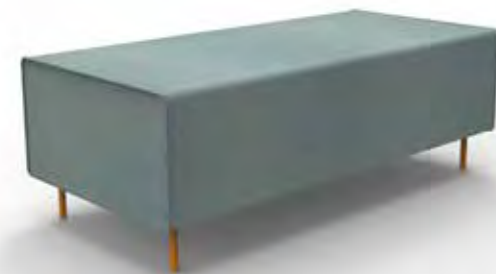

1245mm W x 585mm D x 430mm H

RETURN LOUNGE - FLRL

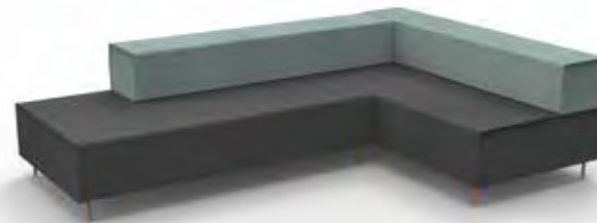

2770mm W x 1830mm D x 710mm H

CORNER - FL6

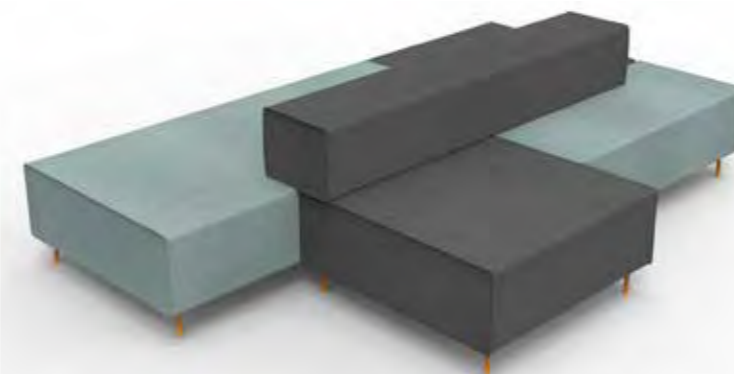

2755mm W x 1880mm D x 710mm H

ISLAND - FL7

Flexi Lounge Range

Flexi Lounge allows you to create a lounge area your way. Mix and match sizes and colours along walls, around corners or in the middle of a space.

Finishes



480mmW x 480mm W x 430mm H

OTTOMAN - FLOTTO



550mm W x 400mm H

PILLOW - FLPL



400mm W x 400mm H

CUSHION - FLCU

CARDINAL SINGLE LOUNGE

Single arm chair in full fabric upholstery with removal back cushion. Black powdercoated solid tube frame and button feet.

CSA

Seat Width	450mm
Seat Depth	480mm
Seat Height	450mm
Back Height	530mm
Weight Rating	Up to 150kg
Warranty	5 Years

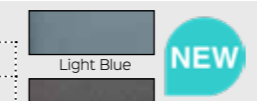

CLOVER LOUNGE CHAIR

Full fabric single lounge chair with stylish tapered back rest and angled cut arm rests.

CLOVER

Seat Width	530mm
Seat Depth	460mm
Seat Height	445mm
Back Height	400mm
Weight Rating	Up to 130kg
Warranty	5 Years

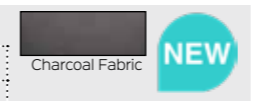

CARDINAL TWO SEATER LOUNGE

Two seater arm lounge in full fabric upholstery with removal back cushion and black powdercoated solid tube frame.

CSA 2 SEATER

Seat Width	1000mm
Seat Depth	510mm
Seat Height	440mm
Back Height	530mm
Weight Rating	Up to 150kg
Warranty	5 Years

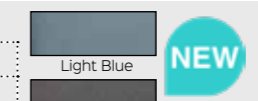

SPLASH CUBE - SINGLE CHAIR

Contemporary style cube shaped chair with stylish chrome sled base underframe.

SPLASHCUBE

Seat Width	460mm
Seat Depth	520mm
Seat Height	500mm
Back Height	330mm
Weight Rating	Up to 120kg
Warranty	3 Years

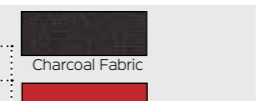

The reception area is so important. It is the first contact with your customer, so create a welcoming, comfortable space. Make the right first impression.

SPACE TUB 1 - SINGLE TUB CHAIR

Single tub chair in compact size with soft foam seat. Black polyurethane leather upholstery.

SPTUB1		Black PU
Seat Width	540mm	
Seat Depth	430mm	
Seat Height	446mm	
Back Height	370mm	
Weight Rating	Up to 120kg	
Warranty	3 Years	



SPACE EXECUTIVE TUB - SINGLE TUB CHAIR

Ideal modern, comfortable seating option in receptions, meeting rooms and breakout areas.

SPEXEC TUB		Black PU
Seat Width	480mm	
Seat Depth	470mm	
Seat Height	480mm	
Back Height	390mm	
Weight Rating	Up to 120kg	
Warranty	3 Years	



VENUS OTTOMAN

Black polyurethane leather ottoman with classic button finish and stainless steel frame.

VENUS ST		Black PU
Seat Width	1030mm	
Seat Depth	540mm	
Seat Height	410mm	
Weight Rating	Up to 130kg	
Warranty	3 Years	



ROUND COFFEE TABLE

Round 600mm diameter coffee table with flat disc base in choice of top and frame colours.

CCT6		Top Finishes	Base Finishes	5 Year Warranty Seal
Table Top Diameter	600mm			
Table Top Height	455mm			
Table Frame Height	430mm			
Warranty	5 Years			



BUDGET COFFEE TABLE

Budget coffee table beech top with ironstone base.

CT96		Beech Top	5 Year Warranty Seal
Table Top Width	900mm		
Table Top Depth	600mm		
Table Top Height	420mm		
Warranty	5 Years		



BLACK GLASS COFFEE TABLE

Black glass and chrome frame coffee table available in two sizes, choose a square or rectangular shape to suit your space.

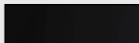
AGT66 and AGT126		Black Glass	5 Year Warranty Seal
Table Top Width	600mm or 1200mm		
Table Top Depth	600mm		
Table Top Height	450mm		
Warranty	5 Years		



VENUS 1 - SINGLE LOUNGE SEAT

Classic designed seat with distinctive button finish in black polyurethane leather and stainless steel frame.

VENUS1		Black PU
Seat Width	630mm	
Seat Depth	500mm	
Seat Height	420mm	
Back Height	400mm	
Weight Rating	Up to 150kg	
Warranty	3 Years	



VENUS 2 - TWO SEATER LOUNGE

Ideal two seater lounge for classic style seating option in receptions, meeting rooms and breakout areas.

VENUS2		Black PU
Seat Width	1120mm	
Seat Depth	500mm	
Seat Height	420mm	
Back Height	400mm	
Weight Rating	Up to 200kg	
Warranty	3 Years	



VENUS 3 - THREE SEATER LOUNGE

Soft black polyurethane leather material for easy cleaning and maintenance. Spacious 3 seater lounge with matching ottoman available.

VENUS3		Black PU
Seat Width	1770mm	
Seat Depth	500mm	
Seat Height	420mm	
Back Height	400mm	
Weight Rating	Up to 300kg	
Warranty	3 Years	



SPACE 1 - SINGLE LOUNGE SEAT

Soft, comfortable single lounge in black polyurethane leather finish and stylish chrome wrap around frame.

SPACE1		Black PU
Seat Width	550mm	
Seat Depth	515mm	
Seat Height	445mm	
Back Height	310mm	
Weight Rating	Up to 150kg	
Warranty	3 Years	



SPACE 2 - TWO SEATER LOUNGE

Ideal two seater lounge for modern, yet comfortable seating option in receptions, meeting rooms and breakout areas.

SPACE2		Black PU
Seat Width	1110mm	
Seat Depth	515mm	
Seat Height	445mm	
Back Height	310mm	
Weight Rating	Up to 200kg	
Warranty	3 Years	



SPACE 3 - THREE SEATER LOUNGE

Soft black polyurethane leather material allows for easy cleaning and maintenance. Spacious 3 seater lounge in modern and stylish design.

SPACE3		Black PU
Seat Width	1670mm	
Seat Depth	515mm	
Seat Height	445mm	
Back Height	310mm	
Weight Rating	Up to 300kg	
Warranty	3 Years	



MARS ROUND OTTOMAN

Round 550mm diameter ottoman in soft fabric upholstery with concealed black feet.

MARS R

Ottoman Width	550mm
Ottoman Depth	550mm
Ottoman Height	450mm
Weight Rating	Up to 130kg
Warranty	5 Years

Charcoal Fabric

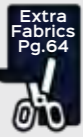

MARS SQUARE OTTOMAN

Square 550mm x 550mm ottoman in soft fabric upholstery with concealed black feet.

MARS S

Ottoman Width	550mm
Ottoman Depth	550mm
Ottoman Height	450mm
Weight Rating	Up to 130kg
Warranty	5 Years

Charcoal Fabric

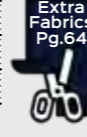

MARS TRIANGLE OTTOMAN

Triangle 550mm x 550mm ottoman in soft fabric upholstery with concealed black feet.

MARS T

Ottoman Width	550mm
Ottoman Depth	550mm
Ottoman Height	450mm
Weight Rating	Up to 130kg
Warranty	5 Years

Charcoal Fabric



CONNECT 2 OTTOMAN

Round ottoman with white powdercoated steel underbase storage and black fabric upholstered seat cushion.

CONNECT 2

Ottoman Width	320mm
Ottoman Depth	320mm
Ottoman Height	420mm
Weight Rating	Up to 110kg
Warranty	3 Years

Black Fabric

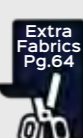

All ottomans available in an extended range of colours.

See page 64.

Use ottoman seats in a variety of areas.

Create an informal breakout space, join them in clusters for multiple sitting, or as a reception or a visitors seat for short time frames.

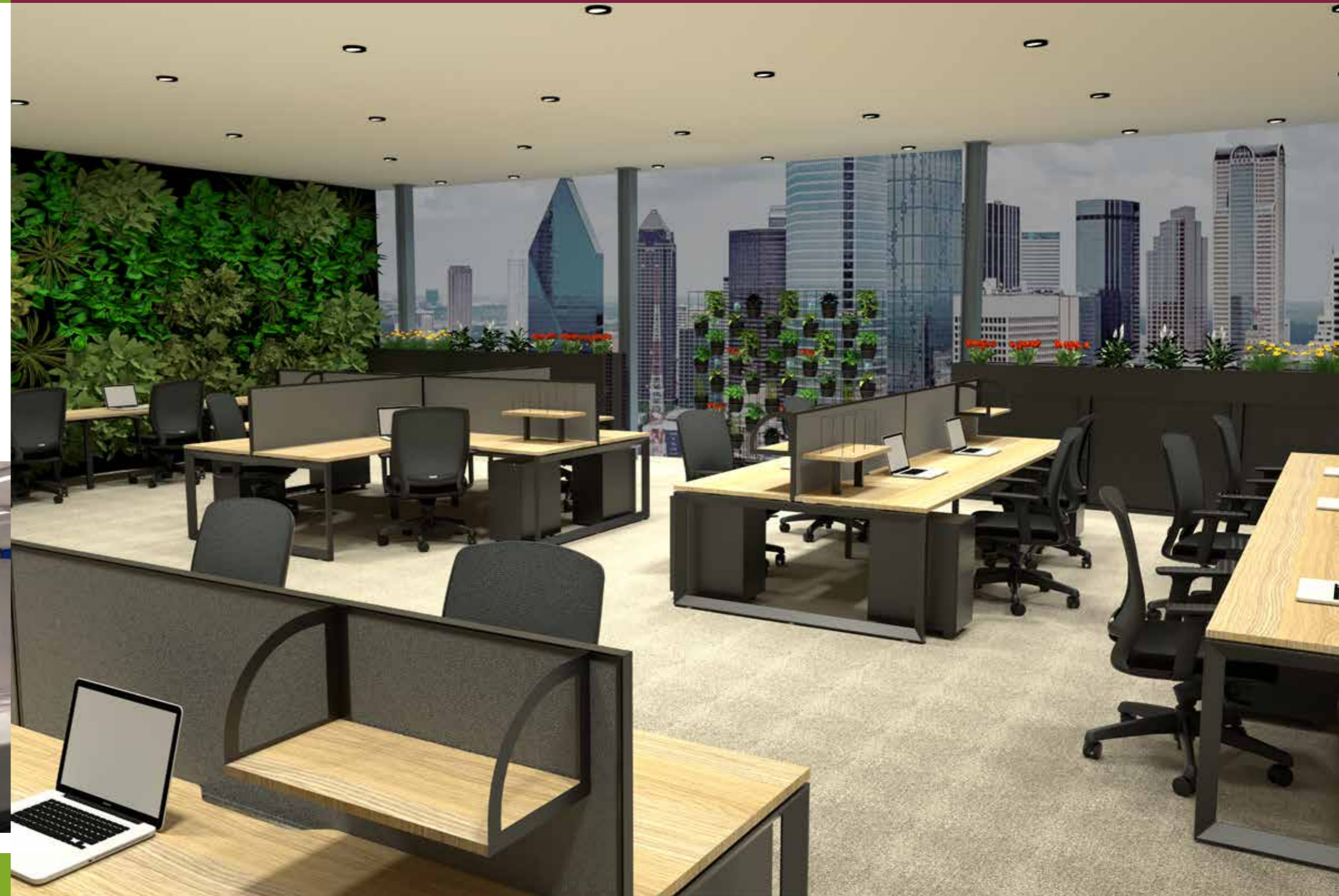

SINGLE SIDED WORKSTATIONS



D-IPLS1P1875 NO / WS · 1 Person Profile Leg

Create a space efficient workspace with Deluxe Infinity, designed to maximise leg space, workstation strength and user communication.



Single Sided Workstation Options

- Choose the number of persons required for your run of desks
- Choose from the Profile or Loop end leg styles
- Choose between 1200mm, 1500mm or 1800mm individual desk top widths x **750mm depth**
- Choose between black or white powdercoated frames and legs
- Choose between natural oak or natural white scalloped top

Top Finishes



Leg and Frame Finishes

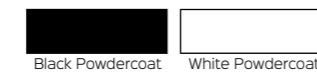

Profile Leg

Product Code	Users	Width	Depth	Height
D-IPLS1P1275	1	1200mm	750mm	730mm
D-IPLS1P1575	1	1500mm	750mm	730mm
D-IPLS1P1875	1	1800mm	750mm	730mm
D-IPLS2P1275	2	2400mm	750mm	730mm
D-IPLS2P1575	2	3000mm	750mm	730mm
D-IPLS2P1875	2	3600mm	750mm	730mm
D-IPLS3P1275	3	3600mm	750mm	730mm
D-IPLS3P1575	3	4500mm	750mm	730mm
D-IPLS3P1875	3	5400mm	750mm	730mm

Loop Leg

Product Code	Users	Width	Depth	Height
D-IPLS1P1275	1	1200mm	750mm	730mm
D-IPLS1P1575	1	1500mm	750mm	730mm
D-IPLS1P1875	1	1800mm	750mm	730mm
D-IPLS2P1275	2	2400mm	750mm	730mm
D-IPLS2P1575	2	3000mm	750mm	730mm
D-IPLS2P1875	2	3600mm	750mm	730mm
D-IPLS3P1275	3	3600mm	750mm	730mm
D-IPLS3P1575	3	4500mm	750mm	730mm
D-IPLS3P1875	3	5400mm	750mm	730mm

D-IPLS3P1875 NO / BL · 3 Person Profile Leg



SINGLE SIDED WORKSTATIONS WITH SCREENS



D-ILLSWS1P1875 NO / BL · 1 Person Loop Leg



D-IPLSWS2P1875 NO / WS · 2 Person Profile Leg



D-ILLSWS3P1875 NW / BL · 3 Person Loop Leg



SINGLE SIDED WORKSTATIONS WITH SCREENS

Single Sided Workstations with Screens Options

- Choose the number of persons required for your run of desks
- Choose from the Profile or Loop end leg styles
- Choose between 1200mm, 1500mm or 1800mm individual desk top widths x **750mm depth**
- Choose between black or white powdercoated frames and legs
- Choose between natural oak or natural white scalloped top
- Choose between black fabric screen with white frame or grey fabric screen with black frame
- Comes with 500mm high x 30mm thick fabric screen

Top Finishes



Leg and Frame Finishes



Screen Finishes



Profile Leg

Product Code	Users	Width	Depth	Height
D-IPLSWS1P1275	1	1200mm	780mm	1200mm
D-IPLSWS1P1575	1	1500mm	780mm	1200mm
D-IPLSWS1P1875	1	1800mm	780mm	1200mm
D-IPLSWS2P1275	2	2400mm	780mm	1200mm
D-IPLSWS2P1575	2	3000mm	780mm	1200mm
D-IPLSWS2P1875	2	3600mm	780mm	1200mm
D-IPLSWS3P1275	3	3600mm	780mm	1200mm
D-IPLSWS3P1575	3	4500mm	780mm	1200mm
D-IPLSWS3P1875	3	5400mm	780mm	1200mm

Loop Leg

Product Code	Users	Width	Depth	Height
D-IPLSWS1P1275	1	1200mm	780mm	1200mm
D-IPLSWS1P1575	1	1500mm	780mm	1200mm
D-IPLSWS1P1875	1	1800mm	780mm	1200mm
D-IPLSWS2P1275	2	2400mm	780mm	1200mm
D-IPLSWS2P1575	2	3000mm	780mm	1200mm
D-IPLSWS2P1875	2	3600mm	780mm	1200mm
D-IPLSWS3P1275	3	3600mm	780mm	1200mm
D-IPLSWS3P1575	3	4500mm	780mm	1200mm
D-IPLSWS3P1875	3	5400mm	780mm	1200mm

DOUBLE SIDED WORKSTATIONS



D-IPLD2P1875 NO / BL · 2 Person Profile Leg

Double Sided Workstation Options

- Choose the number of persons required for your double sided run of desks
- Choose from the Profile or Loop end leg styles
- Choose between 1200mm, 1500mm or 1800mm individual desk top widths x **750mm depth**
- Choose between black or white powdercoated frames and legs
- Choose between natural oak or natural white scalloped top
- Choose to have optional infill rail to fill centre gap - see Infinity accessories page

Top Finishes



Leg and Frame Finishes



The Deluxe Infinity is a modular system that can suit any number of users required, contact us today for more information.



Profile Leg

Product Code	Users	Width	Depth	Height
D-IPLD2P1275	2	1200mm	1530mm	730mm
D-IPLD2P1575	2	1500mm	1530mm	730mm
D-IPLD2P1875	2	1800mm	1530mm	730mm
D-IPLD4P1275	4	2400mm	1530mm	730mm
D-IPLD4P1575	4	3000mm	1530mm	730mm
D-IPLD4P1875	4	3600mm	1530mm	730mm
D-IPLD6P1275	6	3600mm	1530mm	730mm
D-IPLD6P1575	6	4500mm	1530mm	730mm
D-IPLD6P1875	6	5400mm	1530mm	730mm

Loop Leg

Product Code	Users	Width	Depth	Height
D-IPLD2P1275	2	1200mm	1530mm	730mm
D-IPLD2P1575	2	1500mm	1530mm	730mm
D-IPLD2P1875	2	1800mm	1530mm	730mm
D-IPLD4P1275	4	2400mm	1530mm	730mm
D-IPLD4P1575	4	3000mm	1530mm	730mm
D-IPLD4P1875	4	3600mm	1530mm	730mm
D-IPLD6P1275	6	3600mm	1530mm	730mm
D-IPLD6P1575	6	4500mm	1530mm	730mm
D-IPLD6P1875	6	5400mm	1530mm	730mm

D-IPLD4P1875 NW / BL · 4 Person Loop Leg



D-IPLD6P1875 NO / WS · 6 Person Profile Leg

DOUBLE SIDED WORKSTATIONS WITH SCREENS



D-IPLDWS2P1875 NO / WS · 2 Person Profile Leg

Double Sided Workstations with Screens Options

- Choose the number of persons required for your run of desks
- Choose from the Profile or Loop end leg styles
- Choose between 1200mm, 1500mm or 1800mm individual desk top widths x **750mm depth**
- Choose between black or white powdercoated frames and legs
- Choose between natural oak or natural white scalloped top
- Choose between black fabric screen with white frame or grey fabric screen with black frame
- Comes with 500mm high x 30mm thick fabric screen

Top Finishes



Leg and Frame Finishes

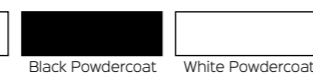

Screen Finishes

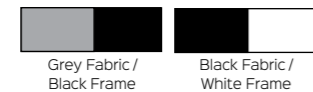

Profile Leg

*Overall Measurements

Product Code	Users	Width	Depth	Height
D-IPLDWS2P1275	2	1200mm	1530mm	1200mm
D-IPLDWS2P1575	2	1500mm	1530mm	1200mm
D-IPLDWS2P1875	2	1800mm	1530mm	1200mm
D-IPLDWS4P1275	4	2400mm	1530mm	1200mm
D-IPLDWS4P1575	4	3000mm	1530mm	1200mm
D-IPLDWS4P1875	4	3600mm	1530mm	1200mm
D-IPLDWS6P1275	6	3600mm	1530mm	1200mm
D-IPLDWS6P1575	6	4500mm	1530mm	1200mm
D-IPLDWS6P1875	6	5400mm	1530mm	1200mm

Loop Leg

D-ILLDWS2P1275	2	1200mm	1530mm	1200mm
D-ILLDWS2P1575	2	1500mm	1530mm	1200mm
D-ILLDWS2P1875	2	1800mm	1530mm	1200mm
D-ILLDWS4P1275	4	2400mm	1530mm	1200mm
D-ILLDWS4P1575	4	3000mm	1530mm	1200mm
D-ILLDWS4P1875	4	3600mm	1530mm	1200mm
D-ILLDWS6P1275	6	3600mm	1530mm	1200mm
D-ILLDWS6P1575	6	4500mm	1530mm	1200mm
D-ILLDWS6P1875	6	5400mm	1530mm	1200mm



D-IPLDWS6P1875 NO / BL · 6 Person Profile Leg

SINGLE CORNER WORKSTATION



D-ILLCWS1P181575 NW / BL · 1800mm x 1500mm Loop Leg

Single Corner Workstation Options

- Choose from the Profile or Loop end leg styles
- Choose between 1500 x 1500mm, 1800 x 1500mm or 1800 x 1800mm individual corner desk top widths x **750mm depth**
- Choose between black or white powdercoated frames and end legs
- Choose between natural oak or natural white top finishes
- All corner tops come with cable access hole

Top Finishes



Leg and Frame Finishes

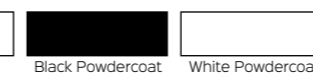

Profile Leg

*Overall Measurements

Product Code	Users	Width	Depth	Height
D-IPLCWS1P151575	1	1500 x 1500mm	750mm	730mm
D-IPLCWS1P181575	1	1800 x 1500mm	750mm	730mm
D-IPLCWS1P181875	1	1800 x 1800mm	750mm	730mm

Loop Leg

Product Code	Users	Width	Depth	Height
D-ILLCWS1P151575	1	1500 x 1500mm	750mm	730mm
D-ILLCWS1P181575	1	1800 x 1500mm	750mm	730mm
D-ILLCWS1P181875	1	1800 x 1800mm	750mm	730mm



D-IPLCWS1P181875 NO / WS · 1800mm x 1800mm Profile Leg



D-ILLCWS1P181875 NO / BL · 1800mm x 1800mm Loop Leg

The Deluxe Infinity Corner Workstation is a modular system that can suit any number of users required, with or without screens and accessories.



Contact us today for more information.

4-PERSON POD OF CORNER WORKSTATIONS WITH SCREENS



D-ILLCWS4PWS181575 NO / WS · 4 Person Loop Leg

4-Person Corner Workstation Pod With Screens Options

- Choose from the Profile or Loop end leg styles to suit your office design and style
- Choose between 1500 x 1500mm, 1800 x 1500mm or 1800 x 1800mm individual corner desk top widths x **750mm depth**
- Choose between natural oak or natural white top finishes
- Choose between black or white powdercoated frames and legs
- Choose between black fabric screen with white frame or grey fabric screen with black frame. Fabric screen is 500mm high x 30mm thick

Top Finishes



Leg and Frame Finishes

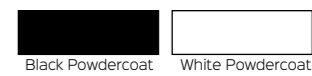

Screen Finishes



Profile Leg

*Overall Measurements

Product Code	Users	Width	Depth	Height
D-IPLCWS4P151575	4	3000 x 3000mm	1500mm	1200mm
D-IPLCWS4P181575	4	3600 x 3000mm	1500mm	1200mm
D-IPLCWS4P181875	4	3600 x 3600mm	1500mm	1200mm

Loop Leg

D-ILLCWS4P151575	4	3000 x 3000mm	1500mm	1200mm
D-ILLCWS4P181575	4	3600 x 3000mm	1500mm	1200mm
D-ILLCWS4P181875	4	3600 x 3600mm	1500mm	1200mm



D-IPLCWS4PWS181875 NW / BL · 4 Person Profile Leg



D-ILLCWS4PWS181875 NO / BL · 4 Person Loop Leg



Why Choose Deluxe Infinity?

- Black or white leg options
- 750mm deep work top for more space
- Natural white or natural oak top finish options
- Scalloped cable access for straight work tops
- Grey screen available with black frame

SWING DOOR CUPBOARDS

Deluxe Infinity lockable swing door cupboards finished in natural white or natural oak laminate with black rigid edging.

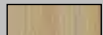
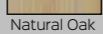
IFSD96, IFSD1245, IFSD1545 and IFSD1845

Size	2 Door - 900 x 600mm 3 Door - 1200 x 450mm or 1500 x 450mm 4 Door - 1800 x 450mm	 Natural Oak
Height	730mm	 Natural White
Features	Lockable, shark nose feature on tops of doors for easy opening, soft close hinges, black rigid edging, adjustable levelling feet	



BOOKCASES

Bookcase with adjustable shelves and black edging feature, aluminium tapered legs, made from E1 rated melamine board.

IFBK12 and IFBK18





Size	900 x 315mm	 Natural Oak
Height	1200mm or 1800mm	 Natural White
Features	25mm thick adjustable shelves, black edging feature and stylish aluminium tapered legs	
Warranty	5 Years	

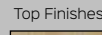
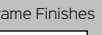

SQUARE TABLES

Modern square meeting table with flat disc base with choice of frame finishes.

CBT990

Top Size	900 x 900mm	Top Finishes	 Natural Oak	Frame Finishes	 White
Table Height	755mm				 Black
Top Finishes	Natural Oak or Natural White		 Natural White		 Stainless Steel
Frame Finishes	White, Black or Stainless Steel				 Black
Warranty	5 Years				



ROUND TABLES

Round meeting table available in 2 different top sizes and colours with flat disc base with choice of frame finishes.

CBT9 and CBT12

Top Size	900mm or 1200mm Diameter	Top Finishes	 Natural Oak	Frame Finishes	 White
Table Height	755mm				 Black
Top Finishes	Natural Oak or Natural White		 Natural White		 Stainless Steel
Frame Finishes	White, Black or Stainless Steel				 Black
Warranty	5 Years				



SINGLE SIDED WORKSTATIONS



IPLS1P187ST NW · 1 Person Profile Leg with Scalloped Top



IPLS2P187 B · 2 Person Profile Leg with Cable Entry Holes



ILLS3P187 NW · 3 Person Loop Leg with Cable Entry Holes

Create a space efficient workspace with Infinity, designed to maximise leg space, workstation strength and user communication.

Single Sided Workstation Options

- Choose the number of persons required for your run of desks
- Choose from the Profile or Loop end leg styles
- Choose between 1200mm, 1500mm or 1800mm individual desk top widths x 700mm depth
- Choose between natural white with cable entry holes, beech with cable entry holes or natural white scalloped top finishes

Top Finishes

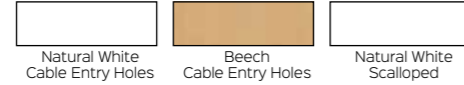

Frame Finish

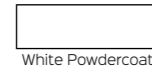

Profile Leg

*Overall Measurements

Product Code	Users	Width	Depth	Height
IPLS1P127	1	1200mm	700mm	730mm
IPLS1P157	1	1500mm	700mm	730mm
IPLS1P187	1	1800mm	700mm	730mm
IPLS2P127	2	2400mm	700mm	730mm
IPLS2P157	2	3000mm	700mm	730mm
IPLS2P187	2	3600mm	700mm	730mm
IPLS3P127	3	3600mm	700mm	730mm
IPLS3P157	3	4500mm	700mm	730mm
IPLS3P187	3	5400mm	700mm	730mm

Loop Leg

ILLS1P127	1	1200mm	700mm	730mm
ILLS1P157	1	1500mm	700mm	730mm
ILLS1P187	1	1800mm	700mm	730mm
ILLS2P127	2	2400mm	700mm	730mm
ILLS2P157	2	3000mm	700mm	730mm
ILLS2P187	2	3600mm	700mm	730mm
ILLS3P127	3	3600mm	700mm	730mm
ILLS3P157	3	4500mm	700mm	730mm
ILLS3P187	3	5400mm	700mm	730mm



SINGLE SIDED WORKSTATIONS WITH SCREENS



ILLSWS1P187 NW · 1 Person Loop Leg with Cable Entry Holes



IPLSWS2P187 B · 2 Person Profile Leg with Cable Entry Holes

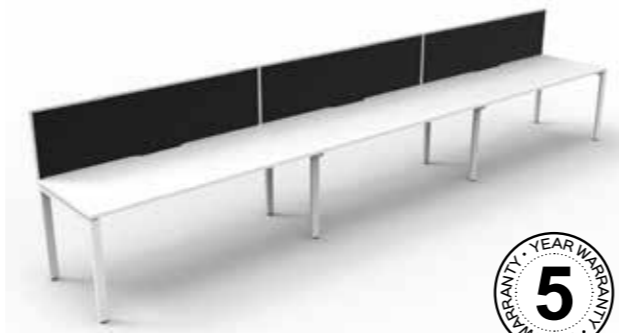

IPLSWS3P187ST NW · 3 Person Loop Leg with Scalloped Top



SINGLE SIDED WORKSTATIONS WITH SCREENS

Single Sided Workstations with Screens Options

- Choose the number of persons required for your run of desks
- Choose from the Profile or Loop end leg styles
- Choose between 1200mm, 1500mm or 1800mm individual desk top widths x 700mm depth
- Choose between natural white with cable entry holes, beech with cable entry holes or natural white scalloped top finishes
- Comes with 500mm high x 30mm thick black fabric screen

Top Finishes

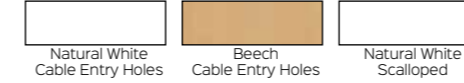

Frame Finish

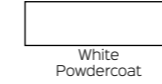

Screen Finish



The Infinity is a modular system that can suit any number of users required, contact us today for more information. Profile Leg

*Overall Measurements

Product Code	Users	Width	Depth	Height
IPLSWS1P127	1	1200mm	730mm	1200mm
IPLSWS1P157	1	1500mm	730mm	1200mm
IPLSWS1P187	1	1800mm	730mm	1200mm
IPLSWS2P127	2	2400mm	730mm	1200mm
IPLSWS2P157	2	3000mm	730mm	1200mm
IPLSWS2P187	2	3600mm	730mm	1200mm
IPLSWS3P127	3	3600mm	730mm	1200mm
IPLSWS3P157	3	4500mm	730mm	1200mm
IPLSWS3P187	3	5400mm	730mm	1200mm

Loop Leg

ILLSWS1P127	1	1200mm	730mm	1200mm
ILLSWS1P157	1	1500mm	730mm	1200mm
ILLSWS1P187	1	1800mm	730mm	1200mm
ILLSWS2P127	2	2400mm	730mm	1200mm
ILLSWS2P157	2	3000mm	730mm	1200mm
ILLSWS2P187	2	3600mm	730mm	1200mm
ILLSWS3P127	3	3600mm	730mm	1200mm
ILLSWS3P157	3	4500mm	730mm	1200mm
ILLSWS3P187	3	5400mm	730mm	1200mm

DOUBLE SIDED WORKSTATIONS



IPLD2P187ST NW · 2 Person Profile Leg with Scalloped Top



ILLD4P187 B · 4 Person Loop Leg with Cable Entry Holes



ILLD6P187 NW · 6 Person Loop Leg with Cable Entry Holes

Double Sided Workstation Options

- Choose the number of persons required for your double sided run of desks
- Choose from the Profile or Loop end leg styles
- Choose between 1200mm, 1500mm or 1800mm individual desk top widths x 700mm depth
- Choose between natural white with cable entry holes, beech with cable entry holes or natural white scalloped top finishes
- Choose to have optional infill rail to fill centre gap - see Infinity accessories page

Top Finishes

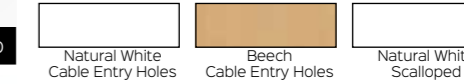

Frame Finish

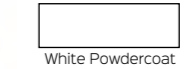

Profile Leg

*Overall Measurements

Product Code	Users	Width	Depth	Height
IPLD2P127	2	1200mm	1430mm	730mm
IPLD2P157	2	1500mm	1430mm	730mm
IPLD2P187	2	1800mm	1430mm	730mm
IPLD4P127	4	2400mm	1430mm	730mm
IPLD4P157	4	3000mm	1430mm	730mm
IPLD4P187	4	3600mm	1430mm	730mm
IPLD6P127	6	3600mm	1430mm	730mm
IPLD6P157	6	4500mm	1430mm	730mm
IPLD6P187	6	5400mm	1430mm	730mm

Loop Leg

ILLD2P127	2	1200mm	1430mm	730mm
ILLD2P157	2	1500mm	1430mm	730mm
ILLD2P187	2	1800mm	1430mm	730mm
ILLD4P127	4	2400mm	1430mm	730mm
ILLD4P157	4	3000mm	1430mm	730mm
ILLD4P187	4	3600mm	1430mm	730mm
ILLD6P127	6	3600mm	1430mm	730mm
ILLD6P157	6	4500mm	1430mm	730mm
ILLD6P187	6	5400mm	1430mm	730mm

DOUBLE SIDED WORKSTATIONS WITH SCREENS



ILLDWS2P187 NW · 2 Person Loop Leg with Cable Entry Holes



IPLDWS4P187 B · 4 Person Profile Leg with Cable Entry Holes

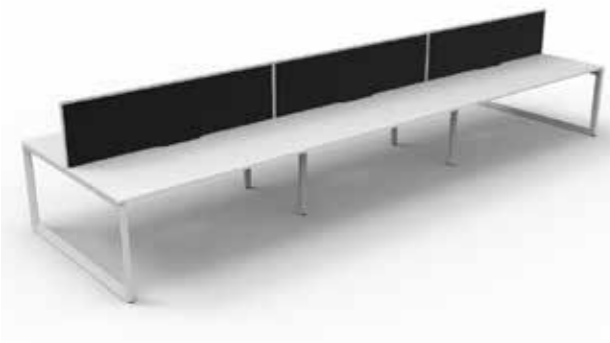

ILLDWS6P187ST NW · 6 Person Loop Leg with Scalloped Top

Double Sided Workstations with Screens Options

- Choose the number of persons required for your double sided run of desks
- Choose from the Profile or Loop end leg styles
- Choose between 1200mm, 1500mm or 1800mm individual desk top widths x 700mm depth
- Choose between natural white with cable entry holes, beech with cable entry holes or natural white scalloped top finishes
- Comes with 500mm high x 30mm thick black fabric screen

Top Finishes

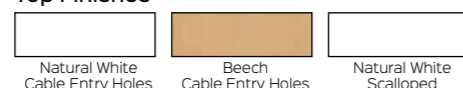

Frame Finish

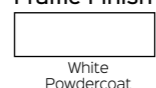

Screen Finish



Profile Leg

Product Code	Users	Width	Depth	Height
IPLDWS2P127	2	1200mm	1430mm	1200mm
IPLDWS2P157	2	1500mm	1430mm	1200mm
IPLDWS2P187	2	1800mm	1430mm	1200mm
IPLDWS4P127	4	2400mm	1430mm	1200mm
IPLDWS4P157	4	3000mm	1430mm	1200mm
IPLDWS4P187	4	3600mm	1430mm	1200mm
IPLDWS6P127	6	3600mm	1430mm	1200mm
IPLDWS6P157	6	4500mm	1430mm	1200mm
IPLDWS6P187	6	5400mm	1430mm	1200mm

Loop Leg

ILLDWS2P127	2	1200mm	1430mm	1200mm
ILLDWS2P157	2	1500mm	1430mm	1200mm
ILLDWS2P187	2	1800mm	1430mm	1200mm
ILLDWS4P127	4	2400mm	1430mm	1200mm
ILLDWS4P157	4	3000mm	1430mm	1200mm
ILLDWS4P187	4	3600mm	1430mm	1200mm
ILLDWS6P127	6	3600mm	1430mm	1200mm
ILLDWS6P157	6	4500mm	1430mm	1200mm
ILLDWS6P187	6	5400mm	1430mm	1200mm

SINGLE CORNER WORKSTATION



IPLCWS1P1815 NW · 1800 x 1500 Profile Leg



ILLCWS1P1818 B · 1800 x 1800 Loop Leg



IPLCWS1P1818 NW · 1800 x 1800 Profile Leg

SINGLE CORNER WORKSTATION

Single Corner Workstation Options

- Choose from the Profile or Loop end leg styles
- Choose between 1500mm x 1500mm, 1800mm x 1500mm or 1800mm x 1800mm individual corner desk top widths x 700mm depth
- Choose between natural white top with a single cable entry hole or beech top with a single cable entry hole

Top Finishes



Frame Finish

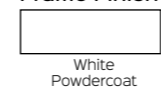

Profile Leg

Product Code	Users	Width	Depth	Height
IPLCWS1P15157	1	1500x 1500mm	700mm	730mm
IPLCWS1P18157	1	1800x 1500mm	700mm	730mm
IPLCWS1P18187	1	1800x 1800mm	700mm	730mm

Loop Leg

Product Code	Users	Width	Depth	Height
ILLCWS1P15157	1	1500x 1500mm	700mm	730mm
ILLCWS1P18157	1	1800x 1500mm	700mm	730mm
ILLCWS1P18187	1	1800x 1800mm	700mm	730mm

The Infinity Corner Workstation is a modular system that can suit any number of users required, with or without screens and accessories.



Contact us today for more information.

4-PERSON POD OF CORNER WORKSTATIONS WITH SCREENS

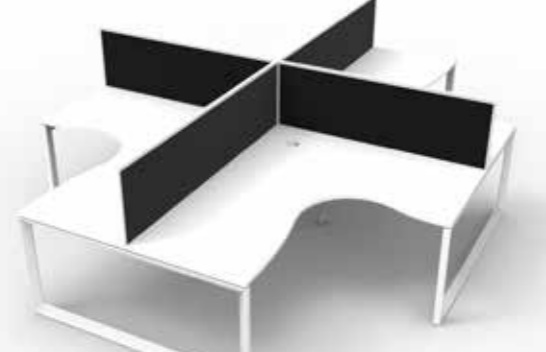

ILLCWS4PWS1815 NW · 1800 x 1500 4-Person Loop Leg



IPLCWS4PWS1818 B · 1800 x 1800 4-Person Profile Leg

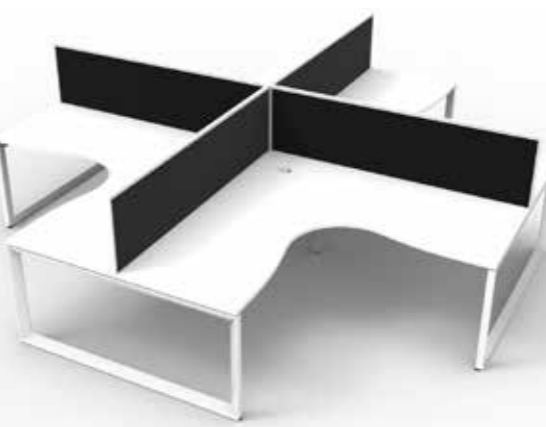

ILLCWS4PWS1818 NW · 1800 x 1800 4-Person Loop Leg

4-Person Corner Workstation Pod With Screens Options

- Choose from the Profile or Loop end leg styles to suit your office design and style
- Choose between 1500mm x 1500mm, 1800mm x 1500mm or 1800mm x 1800mm individual corner desk top widths x 700mm depth
- Choose between natural white top with a single cable entry hole or beech top with a single cable entry hole
- Comes with 500mm high x 30mm thick black fabric screen

Top Finishes



Frame Finish

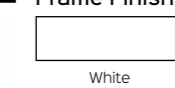

Screen Finish



Profile Leg

Product Code	Users	Width	Depth	Height
IPLCWS4P15157	4	3000x 3000mm	1430mm	1200mm
IPLCWS4P18157	4	3600x 3000mm	1430mm	1200mm
IPLCWS4P18187	4	3600x 3600mm	1430mm	1200mm

Loop Leg

ILLCWS4P15157	4	3000x 3000mm	1430mm	1200mm
ILLCWS4P18157	4	3600x 3000mm	1430mm	1200mm
ILLCWS4P18187	4	3600x 3600mm	1430mm	1200mm

Why Choose Infinity?

- Simple, clean white legs and frames
- 700mm deep work top for tighter offices
- Natural white or beech top finish options
- Cable entry access holes for work tops
- Standard black fabric screen

INFINITY CENTRE SCREEN

Centre screen with pinnable fabric and black or white frame colour finishes to match Deluxe and Infinity ranges.

IS1200, IS1500 and IS1800

Width	1200, 1500 or 1800mm	Grey / Black Frame
Height	500mm	Black / White Frame
Thickness	30mm	
Warranty	5 Years	



INFINITY RETURN DIVIDER

Return dividing screens with screw fixings in matching screen and frame colour finishes for Deluxe and Infinity ranges.

IS700

Width	690mm	Grey / Black Frame
Height	350mm	Black / White Frame
Thickness	20mm	
Warranty	5 Years	



INFINITY INFILL PANEL

Infill panels for back to back workstations without screens, fills 30mm gap between back to back desk tops.

D-IF12, D-IF15 and D-IF18

Width	1200, 1500 or 1800mm	Black
Depth	30mm	White
Height	30mm	
Finish	Black or White	
Warranty	5 Years	



INFINITY DESK MOUNTED SHELF

25mm thick E1 rated enviroboard shelf with 4 x wire dividers. Matching finishes for Infinity and Deluxe ranges.

DMSHELF

Width	600mm	Natural Oak / Black
Depth	300mm	Natural White / White
Overall Height	450mm	
Desk Top to Shelf Height	208mm	
Warranty	5 Years	



INFINITY SCREEN HUNG SHELF

18mm thick E1 rated enviroboard shelf with powdercoated steel shelf brackets, available in 2 matching Infinity finishes.

ISHSELF600

Width	600mm	Natural Oak / Black
Depth	270mm	Natural White / White
Height	250mm	
Warranty	5 Years	



ETERNITY SLIMLINE MOBILE PEDESTAL

Slimline powdercoated steel mobile pedestal with 2 personal drawers and 1 file drawer, fifth wheel for stability and anti-tilt.

EMP3 WB

Width	300mm	White / Black
Depth	535mm	
Height	580mm	
Warranty	10 Years	



SINGLE TIER CABLE BASKET KIT

Under desk cable basket kit to organise cables, for power only. Includes basket, power module, gpo clip and lead.

SWBK

Available Widths	650mm, 950mm, 1250mm or 1550mm	White
Available Options	2 x GPO 4 x GPO	Black
Finish	White or Black	
Warranty	2 Years	



DUAL TIER CABLE BASKET KIT

Under desk cable basket kit to organise cables, power and data. Includes baskets, power module, gpo clip, data tile and lead.

SWBK

Available Widths	650mm, 950mm, 1250mm or 1550mm	White
Available Options	2 x GPO + 1-10 Data Provision 4 x GPO + 1-10 Data Provision	Black
Finish	White or Black	
Warranty	2 Years	



BOARDROOM TABLE BOX

Sits in table top, lid closes to obscure power and data points when not in use.

SWTB

Available Options	2 x GPO + 3 Data Provision 4 x GPO + 4 x Data Provision 4 x GPO + 5 x Data Provision 6 x GPO + 6 x Data Provision 8 x GPO + 8 x Data Provision	White
Finish	White, Black or Silver	Black
Warranty	2 Years	Silver



POP UP POWER

Pop up power module for hot desks or occasional workstations. Offers above desk power, data and USB, pop up when in use.

SWPOP

Available Options	2 x Rotated GPO 1 x GPO + 2 x USB	White
Finish	White or Black	Black
Warranty	2 Years	



POWER RAIL

Above desk power and data rail with USB option, clamps onto desk top.

SWPR

Available Options	2 x Rotated GPO 1 x GPO + 2 x USB 2 x GPO + 2 x USB 2 x Rotated GPO + 2 Data Provision 4 x GPO + 3 x Data Provision 1 x GPO, 1 x Wireless Charging + 1 x USB	White
Finish	White or Black	Black



IN DESK MODULE

In desk module for hot desks or occasional workstations. Above desk power, data and USB, fits into 80mm cable entry hole.



SWHD

Available Options	1 x GPO 1 x GPO, 2 x USB + 1 x Keystone Jack	White
Finish	White or Black	Black
Warranty	2 Years	



ECHO WIRELESS CHARGER

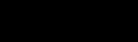

Wireless fast charging module that can fit into desk top. Check compatibility with phone brands.

ECHO		
Width	60mm Diameter	White
Power	15W	
Available Options	500mm TAG lead with L3F splitter or 1500mm lead with 3-pin plug	Black
Warranty	2 Years	



POWER POLE AND UMBILICAL



2.1m or 2.8m power pole or umbilical kits to bring power to your workstation.

POWER POLE AND UMBILICAL		
Desk to Ceiling Kit - 2.1m	2.1m power pole or umbilical kit for desk to ceiling power with ceiling kit, under desk mounting bracket, desk grommet and cover	White
Floor to Ceiling Kit - 2.8m	2.8m power pole or umbilical kit for floor to ceiling power with ceiling kit, floor bracket and cover	Black
Warranty	2 Years	



ATOM USB CHARGING MODULE

USB charging module which can be integrated into desk top or fixed underneath desk top, or lounges with mounting bracket.

ATOM		
Available Options	2 x USB *Under-desk mounting bracket sold separately*	Black
Finish	White or Black	
Warranty	2 Years	



BLINKY POWER POD

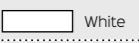

Multi-power pod with different power configurations available. 135mm diameter cutout required to insert into work top.

BLINKY		
Width	135mm Diameter	White
Available Options	3 x GPO + 500mm TAG lead 3 x GPO + 1500mm lead with 10A 3-pin plug 3 x GPO + 3 x Type-C/A Fast Charge + 500mm TAG lead 3 x GPO + 3 x Type-C/A Fast Charge + 1500mm lead with 10A 3-pin plug	Black
Warranty	2 Years	



ODYSSEY POWER DOCK

The complete power solution for where shared power is needed. Use in boardrooms, conference areas, hot desking or meetings.

ODYSSEY		
Power	4 x GPO + 2 x Type C/A USB Fast Charge + 1500mm lead with 10A 3-pin plug	Black
Finish	White or Black	
Warranty	2 Years	
Available Options	*Other Configurations Available	



TRAX

1200mm cable tray to workstation solution for height adjustable desks, includes tray base fixing, and under desk bracket.

TRAX		
Available Options	Single Compartment or Dual Compartment	Black
Length	1200mm	
Finish	White or Black	
Warranty	2 Years	



SCREEN CONFIGURATIONS

Slimline workstation system offering flexibility in configuration, with 2 different screen heights and multiple leg options.

SCREEN STRAIGHT POD

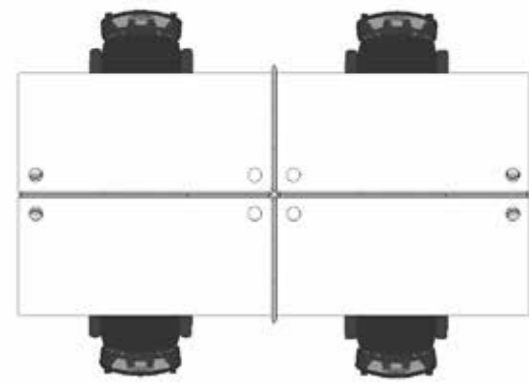

COMPONENTS · Tops · T127, T157 or T187
1200W x 700D · 1500W x 700D · 1800W x 700D
Screens · SC1212, SC1512, SC1812 BU or GR
1200W · 1500W · 1800W · 1250H or 1650H
Joining Pole · SC12/90 · 90° Degree Pole
Legs · SPLEG BS, BL or WS · Spleg Legs

SCREEN CORNER POD

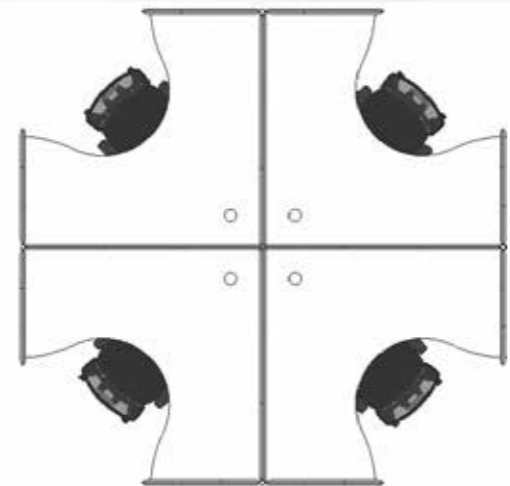

COMPONENTS · Tops · T1515, T1812, T1815 or T1818
1500 x 1500 · 1800 x 1200 · 1800 x 1500 · 1800 x 1800
Screens · SC1212, SC1512, SC1812 BU or GR
1200W · 1500W · 1800W · 1250H or 1650H
Joining Pole · SC12/90 · 90° Degree Pole
Legs · DC60 CH, BL or WS · DC-60 Legs

SCREEN 120° DEGREE POD

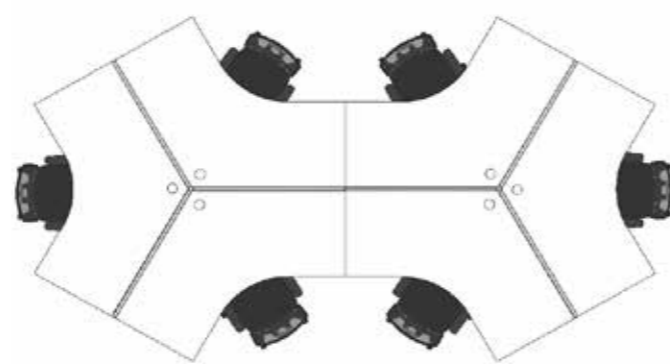

COMPONENTS · Tops · T1212-12-7 · 120° Degree Top
1200W x 1200W x 700D
Screens · SC1212, SC1216 BU or GR
1200W · 1250H or 1650H
Joining Pole · SC12/120 · 120° Degree Pole
Legs · DC60 CH, BL or WS · DC-60 Legs

SCREEN COMPONENTS

CHOOSE YOUR TABLE TOP

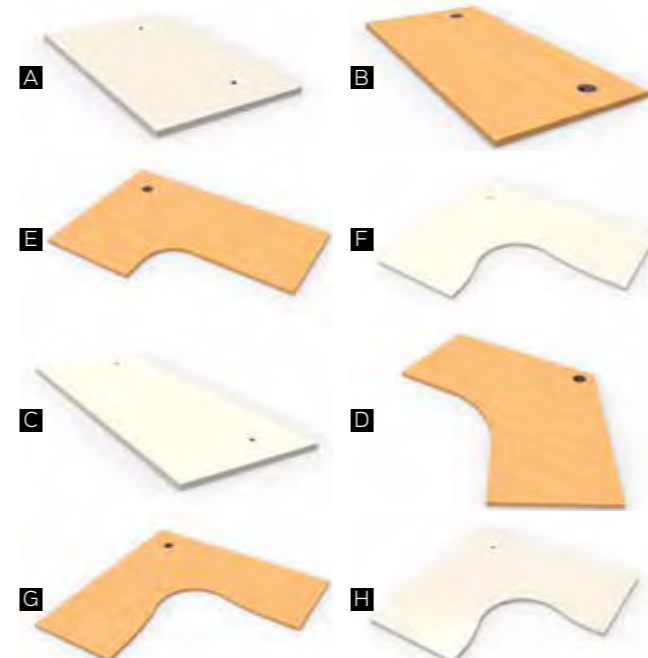
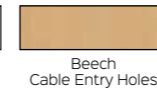
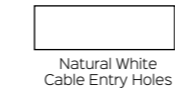

Image	Code	Width	Depth	Thickness
A	T127	1200mm	700mm	25mm
B	T157	1500mm	700mm	25mm
C	T187	1800mm	700mm	25mm
D	T1212-12	1200 x 1200mm	700mm	25mm
E	T1812	1800 x 1200mm	700mm	25mm
F	T1815	1800 x 1500mm	700mm	25mm
G	T1818	1800 x 1800mm	700mm	25mm
H	T1515	1500 x 1500 mm	700mm	25mm

Top Finishes



CHOOSE YOUR LEG STYLE



Image	Code	Product	Size	Qty
I	SPLEG	Span Leg	560mm W x 705mm H	2
J	AD-LEG	Adjustable Leg	70mm Dia. x 650-800mm H	2
K	DC60	Round Leg	60mm Dia. x 705mm H	4
L	CLEG	C Leg	550mm D x 705mm H	2

JOINING POLES



1250mm or 1650mm H
Link screens at 90°, 180° or
120° degrees dependant on workstation configuration.
Use in corners or to join 750mm W return screens.

CHOOSE YOUR SCREEN



M 1250mm H Screen in Blue or Grey with Charcoal Melamine Base



N 1650mm H Screen in Blue or Grey with Charcoal Melamine Base

Image	Code	Width	Depth	Height
M	SC1212	1200mm	30mm	1250mm
M	SC1512	1500mm	30mm	1250mm
M	SC1812	1800mm	30mm	1250mm
	SC712	750mm	30mm	1250mm
N	SC1216	1200mm	30mm	1650mm
N	SC1516	1500mm	30mm	1650mm
N	SC1816	1800mm	30mm	1650mm
	SC716	750mm	30mm	1650mm

Screen Finishes

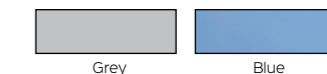

Screens available in an
extended range of colours.
See page 64.

CHOOSE YOUR SCREEN ACCESSORIES

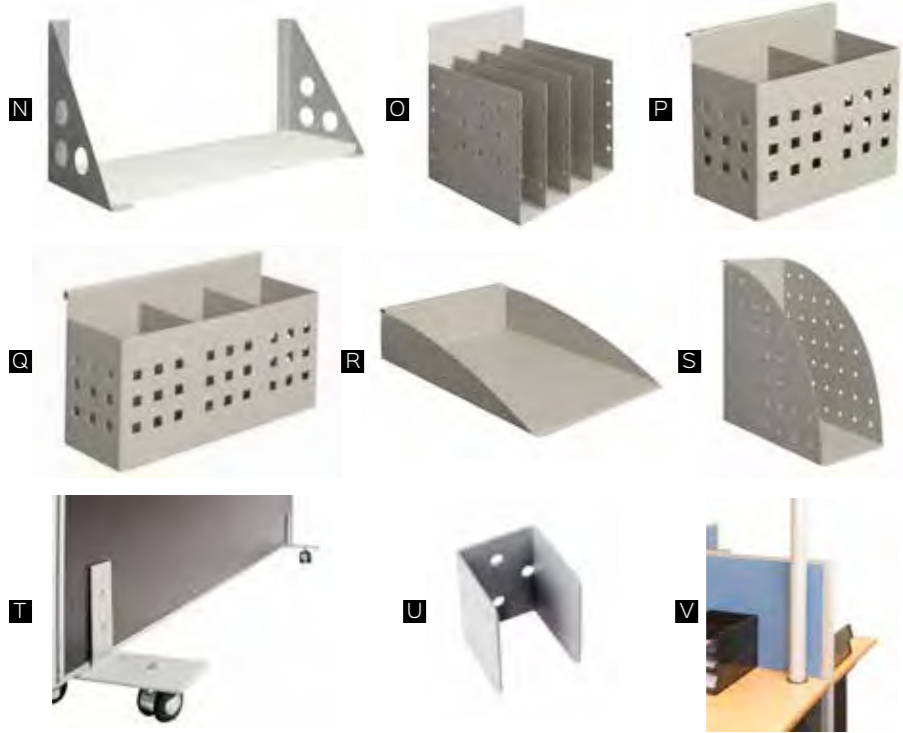
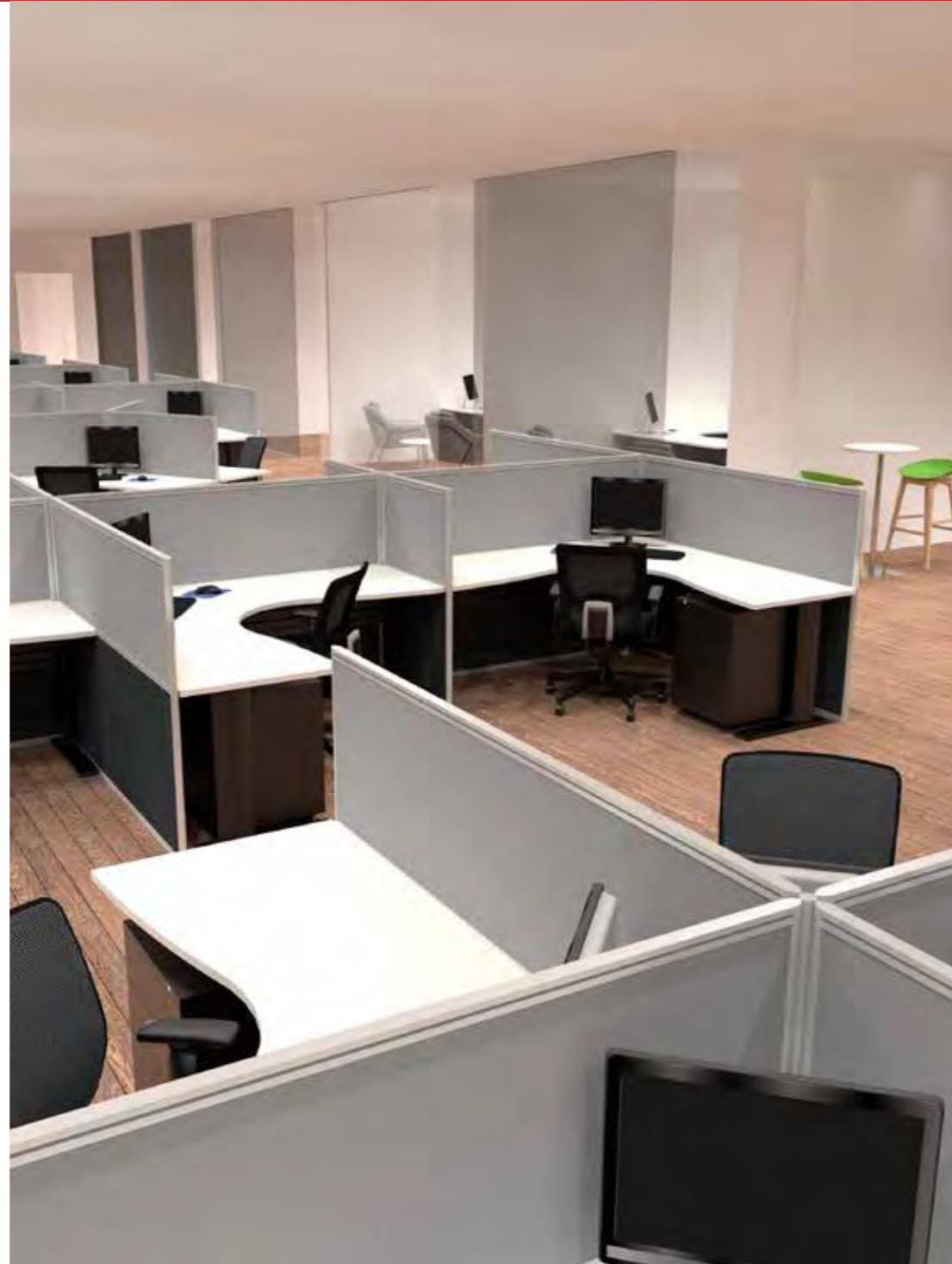

Image	Code	Description	Colour
N	SCSHELF SCSHELF BRACKET	900mm W Shelf (Brackets Sold Separately) Silver Shelf Brackets (Shelf Sold Separately)	Beech or Natural White Shelf
O	SCDOC DIVIDE	4 Space Document Divider	Silver
P	SCPENHOLDER 2	Double Pen Holder	Silver
Q	SCPENHOLDER 3	Triple Pen Holder	Silver
R	SCDOCTRAY	A4 Document Tray	Silver
S	SCFILE HOLDER	File Holder	Silver
T	SCFREE STANDING FEET	Free Standing Detachable Castor Feet	Silver
U	SCWALLBRACKET	Wall to Screen Starter Bracket	Silver
V	SW2.1 POWER POLE or SW2.8 POWER POLE	Power Pole (Available in 2.1m or 2.8m H)	Silver



STRAIGHT DESKS



RSD187M WNW · Natural White Top and White Frame



RSD187M SNW · Natural White Top and Silver Frame



RSD187M BB · Beech Top and Black Frame

CORNER WORKSTATIONS



RSCWS1818M BNW · Natural White Top and Black Frame



RSCWS1818M WB · Beech Top and White Frame



RSDR1818M SNW · Natural White Top and Silver Frame

Span Workstation Options
Workstations your way, mix and match colours and sizes. The Span range of desking can be configured in back to back desk layouts and pods of workstations. Contact us today for more information.



Top Finishes

Natural White Cable Entry Holes
 Beech Cable Entry Holes

Frame Finishes

White
 Silver
 Black

- Choose between 1200mm, 1500mm or 1800mm straight desk top widths or 1800 x 1200mm, 1500 x 1500mm, 1800 x 1500mm or 1800 x 1800mm corner workstation top widths x 700mm depth
- Choose between natural white or beech melamine tops with cable entry holes for cable management
- Choose between white, silver or black powdercoated steel modesty panel and legs

Product Code	Width	Depth	Height
RSD127	1200mm	700mm	730mm
RSD157	1500mm	700mm	730mm
RSD187	1800mm	700mm	730mm
RSCWS1812	1800 x 1200mm	700mm	730mm
RSCWS1515	1500 x 1500mm	700mm	730mm
RSCWS1815	1800 x 1500mm	700mm	730mm
RSCWS1818	1800 x 1800mm	700mm	730mm
RSDR1818	1800mm	700mm	730mm
	1100 x 600mm D Return		

UNDER DESK STORAGE

Melamine mobile pedestal with 2 x personal drawers and 1 x file drawer. Lockable with metal runners and fifth wheel for stability.

SPMP3

Width	447mm
Depth	465mm
Height	690mm
Weight Rating	30kg per Drawer
Finish	Natural White or Beech
Warranty	5 Years

Finishes

Natural White
 Beech



CUPBOARD

Full door cupboard with 1 x fixed mid shelf and 3 x adjustable shelves. Fully lockable with 2 keys included.

SP2FD18

Width	900mm	<input type="checkbox"/> Natural white
Depth	450mm	<input type="checkbox"/> Beech
Height	1800mm	
Finish	Natural White or Beech	
Warranty	5 Years	



BOOKCASE

Open bookcase available in 2 heights. 1200mm H with 3 x adjustable shelves, 1800mm H with 4 x adjustable shelves.

SPBC12 and SPBC18

Width	900mm	<input type="checkbox"/> Natural white
Depth	315mm	<input type="checkbox"/> Beech
Height	1200mm or 1800mm	
Finish	Natural White or Beech	
Warranty	5 Years	



CREDENZA

Sliding door lockable credenza with 2 x adjustable shelves. Fully lockable with 2 keys included.

SPC12 and SPC18

Width	1200mm or 1800mm	<input type="checkbox"/> Natural white
Depth	450mm	<input type="checkbox"/> Beech
Height	730mm	
Finish	Natural White or Beech	
Warranty	5 Years	



HUTCH

Overhead hutch which includes adjustable shelves. 1200mm W with 2 vertical sections, 1800mm W with 3 vertical sections.

SPH12 and SPH18

Width	1200mm or 1800mm	<input type="checkbox"/> Natural white
Depth	315mm	<input type="checkbox"/> Beech
Height	1070mm	
Finish	Natural White or Beech	
Warranty	5 Years	





Change the way you communicate. From round tables for small, informal groups, to flip top and folding tables. Boardroom tables, meeting, breakout areas, kitchen, training and education.



AIR ROUND TABLE

Round meeting table with modern tripod polished aluminium base available with choice of top finishes in 900mm diameter.

RAR900		Top Finishes
Top Diameter	900mm	
Table Height	750mm	Base Finishes
Top Finish	Natural White, Beech, Cherry or Natural Oak	
Warranty	5 Years	



TYPHOON ROUND TABLE

Round meeting table with 4 star black and polished aluminium base with adjustable feet.

TTR900 and TTR1200		Top Finishes
Top Diameter	900mm or 1200mm	
Table Height	730mm	Base Finishes
Top Finish	Natural White, Beech, Cherry or Natural Oak	
Base Finish	Polished Aluminium and Black	



DISC BASE TABLE

Round meeting table available in 2 different top sizes and colours with flat disc base with choice of frame finishes.

CBT9 and CBT12		Top Finishes
Top Diameter	900mm or 1200mm	
Table Height	755mm	Base Finishes
Top Finish	Natural White, Beech, Cherry or Natural Oak	
Base Finish	Stainless Steel, White or Black	



FOUR STAR BASE ROUND TABLE

Round meeting table with 4 star base available in chrome, white or black finish. Range of top colours in 2 different sizes.

RSRT 9/12, RWRT 9/12 and RBRT9/12		Top Finishes
Top Diameter	900mm or 1200mm	
Table Height	730mm	Base Finishes
Top Finish	Natural White, Beech, Cherry or Natural Oak	
Base Finish	Chrome, White or Black	
Warranty	5 Years	



IRONSTONE BASE ROUND TABLE

Round meeting table with solid melamine ironstone base, 25mm thick top available in 2 sizes and finishes.

CRM9 and CRM12		Top Finishes
Top Diameter	900mm or 1200mm	
Table Height	730mm	Base Finishes
Top Finish	Beech or Cherry	
Base Finish	Ironstone	
Warranty	5 Years	



TYPHOON FLIP TOP TABLE

Flip top table with polished aluminium and black frame, locking castors on wheels and table links available as optional extra.

TFT1575 and TFT1875		Top Finishes
Top Size	1500 x 750mm or 1800 x 750mm	
Table Height	750mm	Base Finishes
Top Finish	Natural White, Beech, Cherry, Grey or Natural Oak	
Base Finish	Polished Aluminium and Black	
Warranty	5 Years	



FOLDING TABLE

Steel frame folding table suitable for heavy duty use, easy to use folding mechanism and adjustable levelling feet.

FFT1575, FFT1875 and FFT189		Top Finishes
Top Size	1500 x 750mm or 1800 x 750mm or 1800 x 900mm	
Table Height	730mm	Base Finishes
Top Finish	Natural White, Beech, Cherry, Appletree or Natural Oak	
Base Finish	Black	
Warranty	3 Years	



FLIP TOP TABLE

Flip top table with silver powdercoated frame, padded pull handle and locking castors. Table links as optional extra.

FTT1575 and FTT1875		Top Finishes
Top Size	1500 x 750mm or 1800 x 750mm	
Table Height	750mm	Base Finishes
Top Finish	Natural White, Beech, Cherry, Grey or Natural Oak	
Base Finish	Precious Silver	
Warranty	3 Years	



AIR BOARDROOM TABLE

Boardroom table with suspended floating top and polished aluminium single or dual stage frame and 1 or 2-piece top.

RAB2412 and RAB3212		Top Finishes
Top Size	2400 x 1200mm 1-Piece Top or 3200 x 1200mm 2-Piece Top	
Top Finish	Natural White, Beech, Cherry or Natural Oak	Base Finishes
Frame Finish	Polished Aluminium	
Warranty	5 Years	



TYPHOON BOARDROOM TABLE

Boardroom table with polished aluminium and black single stage or dual stage frame with 1 or 2-piece top in range of finishes.

TTR189, TTR2412 and TTR3212		Top Finishes
Top Size	1800 x 900mm, 2400 x 1200mm or 3200 x 1200mm	
Top Finish	Natural White, Beech, Cherry, or Natural Oak	Base Finishes
Frame Finish	Polished Aluminium and Black	
Warranty	5 Years	



IRONSTONE BASE BOARDROOM TABLE

Rectangular shaped mealtime top with ironstone melamine base. Available in T2412 1-piece top or T3212 2-piece top.

CBT2412 and CBT3212		Top Finishes
Top Size	2400 x 1200mm 1-Piece Top or T3212 2-Piece Top.	
Top Finish	Natural White, Beech, Cherry or Natural Oak	Base Finishes
Base Finish	Ironstone	
Warranty	5 Years	



EDGE FOLDING TABLE

Folding table with black rubber strip edging, quick release mechanism, includes 2 x table links.

FBT2410		Top Finishes
Top Size	2400 x 1000mm	
Table Height	743mm	Base Finishes
Top Finish	Natural White or Driftwood	
Frame Finish	Black and Polished Aluminium	
Warranty	5 Years	



STEEL FRAME TABLE

Black steel frame with adjustable levelling feet, available in 4 sizes with melamine rectangular top in range of finishes.

SFT126, SFT1575, SFT1875, SFT189		Top Finishes
Top Size	1200 x 600mm, 1500 x 750mm, 1800 x 750mm or 1800 x 900mm	
Table Height	730mm	Base Finishes
Top Finish	Natural White, Beech, Cherry, Grey or Natural Oak	
Base Finish	Black	
Warranty	3 Years	



SILVER FRAME TABLE

Rectangular shaped table top with silver angled frame and adjustable feet. Available in two sizes and different top finishes.

RST1875 and RST189		Top Finishes
Top Size	1800 x 750mm or 1800 x 900mm	
Table Height	730mm	Base Finishes
Top Finish	Natural White, Beech, Cherry, Grey or Natural Oak	
Base Finish	Precious Silver	
Warranty	3 Years	



DRAFTING HEIGHT STEEL FRAME TABLE

Rectangular drafting height table with black powdercoated steel frame and 900mm top height.

9SFT1575 and 9SFT189		Top Finishes
Top Size	1500 x 750mm or 1800 x 900mm	
Table Height	900mm	Base Finishes
Top Finish	Natural White, Beech, Cherry, Grey or Natural Oak	
Base Finish	Black	
Warranty	3 Years	



HIGH BAR TABLE

Rectangular high bar table with black powdercoated frame including cross bar foot rest and adjustable levelling feet.

HBT189		Top Finishes
Top Size	1800 x 900mm	
Table Height	1050mm	Base Finishes
Top Finish	Natural White, Beech, Cherry, Grey or Natural Oak	
Frame Finish	Black	
Warranty	3 Years	



DRY BAR TABLE

Dry bar height table perfect for any kitchen, breakout or hospitality setting with choice of round top finishes.

CDBT		Top Finishes
Top Size	600mm Diameter	
Table Height	1085mm	Base Finishes
Base Finish	Stainless Steel, White or Black	
Warranty	5 Years	





SINGLE SIDED · WITH OR WITHOUT SCREEN



NPM1P1875 NO/WS · Natural Oak Top and White Frame

DOUBLE SIDED · WITH OR WITHOUT SCREEN



NPM2P1875 NO/BL · Natural Oak Top and Black Frame



NPM1PWS1875 NW/BL · Natural White Top and Black Frame



NPM2PWS1875 NW/WS · Natural White Top and White Frame



NPM1PWS1875 NO/WS · Natural Oak Top and White Frame



NPM2PWS1875 NO/BL · Natural Oak Top and Black Frame

Paramount Electric Height Adjustable Workstation Options

- Choose between a single sided or double sided height adjustable workstation
- Choose between 1500mm or 1800mm individual desk top widths x 750mm depth
- Choose between natural oak scalloped top or natural white scalloped top finishes
- Choose between no screen or matching screen to your chosen frame colour - grey fabric screen with black frame or black fabric screen with white frame

Top Finishes



Screen and Frame Finishes



The Paramount range includes 25mm thick scalloped table tops, a powdercoated 3-stage frame and single heavy duty motor per user. Built in cable tray with provisions for GPO and Data per user on each workstation.

Product Code	Users	Screen	Width	Depth	Height Range
NPM1P1575	1	None	1500mm	750mm	655 - 1259mm
NPM1P1875	1	None	1800mm	750mm	655 - 1259mm
NPM1PWS1575	1	Yes	1500mm	780mm	655 - 1259mm
NPM1PWS1875	1	Yes	1800mm	780mm	655 - 1259mm
NPM2P1575	2	None	1500mm	1530mm	655 - 1259mm
NPM2P1875	2	None	1800mm	1530mm	655 - 1259mm
NPM2PWS1575	2	Yes	1500mm	1530mm	655 - 1259mm
NPM2PWS1875	2	Yes	1800mm	1530mm	655 - 1259mm

Optional Set Controller

Product Code: SS-PSC

Programmable handset can be added to electric height adjustable desk at anytime. Offers the ability to program 3 different height settings for up to 3 individual users each. Use the up and down buttons for quick adjustment to desk height without affecting the programmed heights.



The benefits of height adjustable desks are now well known. Setting the correct sitting height and alternating between sitting and standing assists with employee wellness and productivity.



whole range of height adjustable solutions - Paramount electric height adjustable workstations are available in single or double sided configurations, with or without matching privacy screens.



STRAIGHT DESK · ELECTRIC HEIGHT ADJUSTABLE



SE-187 SNW · Natural White Top and Silver Frame

CORNER WORKSTATION · ELECTRIC HEIGHT ADJUSTABLE



SE-18187 BNW · Natural White Top and White Frame

Span Electric Height Adjustable Workstation Options

- Choose between an electric height adjustable straight desk or corner workstation
- Choose between 1200mm, 1500mm or 1800mm straight individual desk top widths or 1800 x 1200mm, 1500 x 1500mm, 1800 x 1500mm and 1800 x 1800mm corner workstation desk tops x 700mm depth
- Choose between natural white or beech melamine tops with cable entry holes
- Choose between white, silver or black electric height adjustable steel frame with matching perforated modesty panel

Top Finishes

Natural White Cable Entry Holes
 Beech Cable Entry Holes

Frame Finishes

White
 Silver
 Black

The Span Electric Height Adjustable range offers desk height adjustment between 685 to 1205mm.

Matching perforated steel modesty panel to chosen frame colour and stiffening rail for 1500mm W and 1800mm W tops.

31mm per second electric height adjustment speed and 100kg maximum top load rating.

Product Code	Width	Depth	Height Range
SE-127	1200mm	700mm	685 - 1205mm
SE-157	1500mm	700mm	685 - 1205mm
SE-187	1800mm	700mm	685 - 1205mm
SE-18127	1800 x 1200mm	700mm	685 - 1205mm
SE-15157	1500 x 1500mm	700mm	685 - 1205mm
SE-18157	1800 x 1500mm	700mm	685 - 1205mm
SE-18187	1800 x 1800mm	700mm	685 - 1205mm

Optional Set Controller

Product Code: SS-PSC
 Programmable handset can be added to electric height adjustable desk at anytime. Offers the ability to program 3 different height settings for up to 3 individual users each. Use the up and down buttons for quick adjustment to desk height without affecting the programmed heights.



BOOST

Boost electric height adjustable workstation frame with 620 to 1250mm height adjustment, compatible with range of tops.

BOOST	Top Finishes
Top Sizes	1200-1800mm W x 600-900mm D
Height	620-1250mm
Features	Dual motor with memory controller for 3 presets
Weight Capacity	125kg
Warranty	10 Years

Natural White Scalloped
 Natural Oak Scalloped
 Natural White Cable Entry
 Beech Cable Entry

White
 Black



FLUX

Electric height adjustable solution for an existing or new fixed desk, available in 2 sizes and finishes. 22mm per second speed.

RF1 and RF2	Top Finishes
Top Width	RF1 - 880mm or RF2 - 950mm
Top Depth	415mm
Height	120-500mm
Weight Capacity	25kg Weight Capacity on Top
Warranty	10 Years

Black or White



SURGE

Stand alone gas lift operated height adjustable desk, control levers each side and 12 different height settings.

RS1 W	Top Finishes
Top Width	1190mm
Top Depth	590mm
Height	750-1100mm
Weight Capacity	22kg Weight Capacity on Top
Warranty	10 Years

White



RISER

Manual height adjustable solution for an existing or new fixed desk, available in 2 sizes and finishes.

RR1 and RR2	Top Finishes
Top Width	RR1 - 680mm or RR2 - 890mm
Top Depth	590mm
Height	150-500mm
Weight Capacity	15kg Weight Capacity on RR1 18kg Weight Capacity on RR2
Height Adjustment	15 Different Height Levels

Black or White



TRIUMPH MANUAL HEIGHT ADJUSTABLE

Manual height adjustable desk with universal left or right hand side crank handle and integrated cable dump tray.

TMA127, TMA157 and TMA187	Top Finishes
Top Width	1200mm, 1500mm or 1800mm
Top Depth	700mm
Height	715-1015mm
Weight Capacity	100kg Weight Capacity on Top
Frame Finish	White Powdercoat
Warranty	5 Years

Natural White
 Beech

White



REFRESH MAT

Anti-fatigue mat for use with all height adjustable solutions when standing. Moulded areas provide massage points for feet.

RRM BL	Top Finishes
Width	800mm
Depth	518mm
Thickness	48mm
Weight	2.4kg
Warranty	10 Years

Black



EXECUTIVE SINGLE MONITOR ARM

Executive gas spring single monitor arm with effortless rotating, pivoting and extendable adjustments.

ESMARM		Black or White
Tilt Range	-85° to 15°	
Screen Size	17" to 27"	
Vesa Size	75 x 75mm or 100 x 100mm	
Weight Limit	Min. 2kg - Max 9kg	
Fixing	Clamp and Grommet Fix Kit	
Warranty	5 Years	



EXECUTIVE DUAL MONITOR ARM

Executive gas spring dual monitor arms with effortless rotating, pivoting and extendable adjustments.

EDMARM		Black or White
Tilt Range	-85° to 15°	
Screen Size	17" to 27"	
Vesa Size	75 x 75mm or 100 x 100mm	
Weight Limit	Min. 2kg - Max 9kg per Arm	
Fixing	Clamp and Grommet Fix Kit	
Warranty	5 Years	



REVOLVE SINGLE MONITOR ARM

Pole mounted single monitor arm with 200-360mm height range and cable management within, in black finish.

RMA1 BL		Black
Arm Reach	425mm	
Pole Height	392mm	
Height	200-360mm	
Weight Limit	10kg	
Movement Range	-85° to 15°	
Warranty	3 Years	



REVOLVE DUAL MONITOR ARM

Pole mounted dual monitor arm with 200-400mm height range and cable management within, in black finish.

RMA2 BL		Black
Arm Reach	360mm per Arm	
Pole Height	450mm	
Height	200-400mm	
Weight Limit	10kg per Arm	
Movement Range	-85° to 15°	
Warranty	3 Years	



ELEVATE SINGLE MONITOR ARM

Single swivel monitor arm with 160-480mm height range, 180° degree portrait or landscape adjustment and clamp fix kit.

ELEVATE		Black or White
Forward Range	500mm	
Vertical Range	160-480mm	
Size Limit	Suits up to 24 Inch Monitor	
Weight Limit	Min. 2kg - Max 8kg	
Movement Range	180°	
Warranty	5 Years	



REVOLVE QUAD MONITOR ARM

Pole mounted quad monitor arm with 200-660mm height range and cable management within, in black finish.

RMA4 BL		Black
Arm Reach	360mm per Arm	
Pole Height	708mm	
Height	200-660mm	
Weight Limit	10kg per Arm	
Movement Range	-85° to 15°	
Warranty	3 Years	

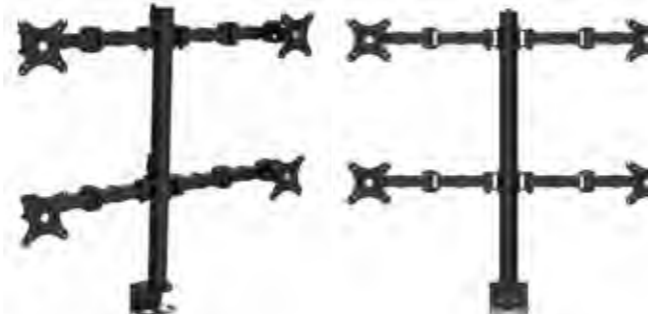



LAPTOP DESK

Melamine open desk in compact size for laptop or hot desk. Matching under desk modesty panel, available in 2 finishes.

CDK96		<input type="checkbox"/>	
Width	900mm	Natural White	
Depth	600mm	<input type="checkbox"/>	
Height	730mm	Grey	
Finish	Natural White or Grey		
Warranty	5 Years		

HOME OFFICE DESK

Melamine open desk available in white and grey finishes, with matching under desk modesty panel. Drawer sold separately.

CDK126 and HDKP1D Single Drawer		<input type="checkbox"/>	
Desk Top Size	1200 x 600mm	Natural White	
Desk Top Height	730mm	<input type="checkbox"/>	
Optional Extra	HDKP1D Single Drawer	Grey	
Finish	Natural White or Grey		
Warranty	5 Years		

OPEN DESK

Melamine open desk available in 2 sizes and 2 different finishes. Includes matching under desk melamine modesty panel.

CDK1575 and CDK189		<input type="checkbox"/>	
Top Size	1500 x 750mm or 1800 x 900mm	Natural White	
Height	730mm	<input type="checkbox"/>	
Finish	Natural White or Grey	Grey	
Warranty	5 Years		

CUPBOARD

Full door cupboard with 1 x fixed mid shelf and 3 x adjustable shelves. Fully lockable with 2 keys included.

SP2FD18		<input type="checkbox"/>	
Width	900mm	Natural White	
Depth	450mm	<input type="checkbox"/>	
Height	1800mm	Grey	
Finish	Natural white or Grey		
Warranty	5 Years		



BOOKCASE

Open bookcase available in 2 heights. 1200mm H with 3 x adjustable shelves, 1800mm H with 4 x adjustable shelves.

SPBC12 and SPBC18		<input type="checkbox"/>	
Width	900mm	Natural White	
Depth	315mm	<input type="checkbox"/>	
Height	1200mm or 1800mm	Grey	
Finish	Natural white or Grey		
Warranty	5 Years		

CREDENZA

Sliding door lockable credenza with 2 x adjustable shelves. Fully lockable with 2 keys included.

SPC12 and SPC18		<input type="checkbox"/>	
Width	1200mm or 1800mm	Natural White	
Depth	450mm	<input type="checkbox"/>	
Height	730mm	Grey	
Finish	Natural white or Grey		
Warranty	5 Years		



CORNER WORKSTATION

Melamine 3-piece corner workstation with under desk modesty panels, available in white and grey finishes.

CWS1818		<input type="checkbox"/>	
Width	1800 x 1800mm	Natural White	
Depth	600mm	<input type="checkbox"/>	
Height	730mm	Grey	
Finish	Natural White or Grey		
Warranty	5 Years		

DESK RETURN

Melamine return to be fixed to any desk to create a corner shaped workstation with extra desk top space.

CR6		<input type="checkbox"/>	
Width	900mm	Natural White	
Depth	600mm	<input type="checkbox"/>	
Height	730mm	Grey	
Finish	Natural White or Grey		
Warranty	5 Years		

DESK HOB



Straight edge hob for use on straight desk or corner workstation. Create a reception or add privacy to a desk.

CHOB18N		<input type="checkbox"/>	
Width	1800mm	Natural White	
Depth	350mm	<input type="checkbox"/>	
Height	400mm	Grey	
Finish	Natural White or Grey		
Warranty	5 Years		



PEDESTALS

CDKP3D Lockable under desk fixed pedestal with 3 drawers.
SPMP3 Lockable 2 drawer and 1 file mobile pedestal with metal runners and fifth wheel for stability, supplied with 2 keys.

Fixed Pedestal	CDKP3D	<input type="checkbox"/>	
CDKP3D Size	465mm x 447mm x 454mm H	Natural White	
Mobile Pedestal	SPMP3	<input type="checkbox"/>	
SPMP3 Size	447mm x 465mm x 690mm H	Grey	
Warranty	5 Years		





STRAIGHT DESK

Melamine open desk available in beech or cherry finishes, with ironstone under desk modesty panel and frame.

CDK96/126/1575/1875/189

Top Size	900 x 600mm, 1200 x 600mm, 1500 x 750mm, 1800 x 750mm or 1800 x 900mm
Height	730mm
Finish	Beech or Cherry with Ironstone
Warranty	5 Years

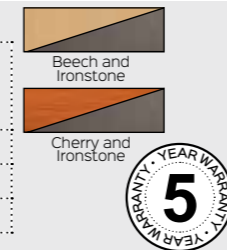

CORNER WORKSTATION

Melamine 3-piece corner workstation available in beech or cherry finishes, with ironstone under desk modesty panel.

RWCWS1212/1215/1218/1221/1515/1815/1818/2115/2118/2121

Desk Top	1200 x 1200mm, 1200 x 1500mm, 1500 x 1500mm, 1800 x 1500mm, 1800 x 1800mm, 2100 x 1500mm, 2100 x 1800mm or 2100 x 2100mm
Height	730mm
Depth	600mm (or 750mm in 1800 x 1800mm)

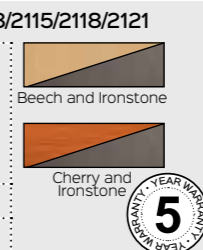

DESK HOB

Straight edge hob for use on straight desk or corner workstation. Create a reception or add privacy to a desk.

CHOB15N and CHOB18N

Top Size	1500 x 350mm or 1800 x 350mm
Height	400mm
Finish	Beech or Cherry with Ironstone
Warranty	5 Years

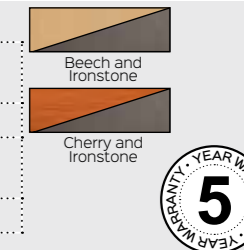

DESK RETURN

Melamine add on desk return piece to create more workspace.

CR45/6/12 and CRP3D

Desk Return	CR45, CR6 or CR12
Size	900 x 450mm, 900 x 600mm or 1200 x 600mm
Warranty	5 Years



FIXED PEDESTAL

Lockable 2 or 3 drawer fixed pedestal which can be added to any desk.

CDKP1D1F, CDKP3D and HDKP1D

CDKP1D1F	2 Drawers - 1 Drawer and 1 File Drawer
CDKP3D	3 Drawers
Single Drawer	HDKP1D (Ironstone Only)
Warranty	5 Years

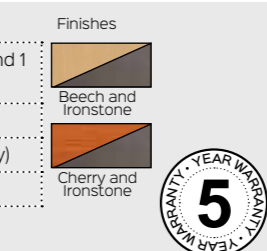

MOBILE PEDESTAL

Mobile pedestals available in a variety of configurations. 2 file drawers, 2 drawers and 1 file drawer or 4 drawers.

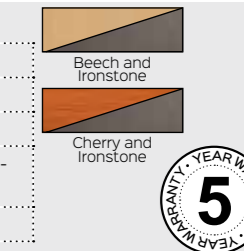

CMP2F, CMP2D1F and CMP4D

CMP2F	2 Drawers
CMP2D1F	2 Drawers and 1 File Drawer
CMP4D	4 Drawers
CMP2D1F-I	2 Drawers and 1 File Drawer - Ironstone
Warranty	5 Years



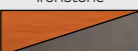

CUPBOARD
Full door cupboard with 1 x fixed mid shelf and 3 x adjustable shelves. Fully lockable with 2 keys included.

CSC2FD

Width	900mm	
Depth	450mm	
Height	1800mm	
Finish	Beech or Cherry with Ironstone	
Warranty	5 Years	

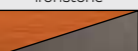

BOOKCASE
Open bookcase available in 900mm or 1200mm H with 3 x adjustable shelves, or 1800mm H with 4 x adjustable shelves.

CBC9, CBC12 and CBC18

Width and Depth	900mm x 315mm	
Height	900mm, 1200mm or 1800mm	
Finish	Beech or Cherry with Ironstone	
Warranty	5 Years	

LOCKABLE WALL UNIT
Wall unit with 2 shelves and lockable half height storage cupboard. Available in beech or cherry with ironstone finishes.

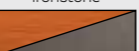

CSC2HD

Width	900mm	
Depth	450mm	
Height	1800mm	
Finish	Beech or Cherry with Ironstone	
Warranty	5 Years	





CREDENZA
Sliding door lockable credenza with 2 x adjustable shelves. Fully lockable with 2 keys.

CMZ1245, CMZ1545 and CMZ1845

Width	1200mm, 1500mm or 1800mm	
Depth	450mm	
Height	730mm	
Finish	Beech with Ironstone or Cherry with Ironstone	
Warranty	5 Years	



HUTCH
Overhead hutch including adjustable shelves over multiple vertical sections.

CH12, CH15 and CH18

Width	1200mm, 1500mm or 1800mm	
Depth	315mm	
Height	1070mm	
Shelves	4 in 1200mm and 1500mm, 6 in 1800mm W	
Warranty	5 Years	



PIGEON HOLE UNIT
Melamine pigeon hole unit with 20 slots, available in beech or cherry and ironstone.

PH20

Width	1040mm	
Depth	380mm	
Height	1040mm	
Finish	Beech or Cherry with Ironstone	
Warranty	5 Years	

FILING CABINET \$339
Melamine pigeon hole unit with 20 slots, available in beech or cherry and ironstone.

C3FC

Width	1040mm	
Depth	380mm	
Height	1040mm	
Finish	Beech or Cherry with Ironstone	
Warranty	5 Years	

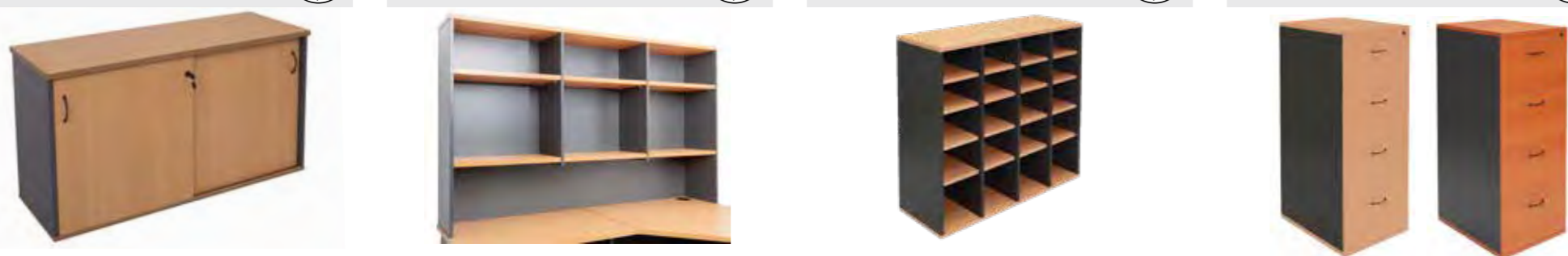

OPEN DESK

Melamine open desk in appletree top finish with ironstone under desk modesty panel and side. Drawers sold separately.

VDK1575 and VDK1875		
Width	1500mm or 1800mm	 
Depth	750mm	
Height	730mm	
Finish	Appletree with Ironstone	
Warranty	5 Years	



METAL LEG DESK



Appletree top with 2 cable entry holes and metal span leg base with perforated modesty panel and legs in black.

VDKMB1575 and VDKMB1875		
Width	1500mm or 1800mm	 
Depth	750mm	
Height	730mm	
Finish	Appletree with Black	
Warranty	5 Years	



DESK HOB

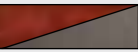

Curved edge hob for use on straight desk or corner workstation. Create a reception or add privacy to a desk.

CHOB18N		
Width	1800mm	 
Depth	350mm	
Height	400mm	
Finish	Appletree with Ironstone	
Warranty	5 Years	



CORNER WORKSTATION



Appletree one piece top with 600mm deep with cable entry hole and melamine 3-piece ironstone base.

VCW186		
Width	1800 x 1800mm	 
Depth	600mm	
Height	730mm	
Finish	Appletree with Ironstone	
Warranty	5 Years	



METAL BASE CORNER WORKSTATION

Appletree 1-piece 700mm deep curved top with black metal base, perforated metal modesty panel and cable entry hole.

VCWMB186		
Width	1800 x 1800mm	 
Depth	700mm	
Height	730mm	
Finish	Appletree with Ironstone	
Warranty	5 Years	



HUTCH

Storage hutch for use on top of melamine base desk or credenza. Includes 4 cupboard spaces and 6 shelf spaces.

VH18		
Width	1800mm	 
Depth	380mm	
Height	1070mm	
Finish	Appletree with Ironstone	
Warranty	5 Years	



CUPBOARD

Full door cupboard with 1 x fixed mid shelf and 3 x adjustable shelves. Fully lockable with 2 keys included.

VSC2FD		
Width	900mm	 
Depth	450mm	
Height	1800mm	
Finish	Appletree with Ironstone	
Warranty	5 Years	



Traditional dark wood finish with ironstone or black frames for desking, 25mm thickness all over. Matching storage for a classic, executive style.





BOOKCASE

Open bookcase with 4 adjustable shelves, appletree finish with ironstone sides.

VBC18		
Width and Depth	900mm	 
Depth	315mm	
Height	1800mm	
Finish	Appletree with Ironstone	
Warranty	5 Years	

CREDENZA

Sliding door lockable credenza with 2 x adjustable shelves. Fully lockable with 2 keys included.

VCZ1245 and VCZ1845		
Width	1200mm or 1800mm	 
Depth	450mm	
Height	730mm	
Finish	Appletree with Ironstone	
Warranty	5 Years	



FILING CABINET

Lockable filing cabinet with 4 drawers of storage space. Appletree finish with ironstone sides and silver handles.



V4FC		
Width	465mm	 
Depth	600mm	
Height	1300mm	
Warranty	5 Years	



PEDESTALS

VDKP1D1F Lockable 2 or VDKP3D 3 drawer fixed pedestal which can be added to any desk.

VMP2D1F Mobile pedestal with 2 drawers and 1 file drawer.

VDKP1D1F	Fixed 2 Drawers - 1 Drawer and 1 File Drawer (Use With Ironstone Base)	
VDKP3D	Fixed 3 Drawers (Use With Ironstone Base)	
VMP2D1F	Mobile Pedestal with 2 Drawers and 1 File Drawer	 
Warranty	5 Years	





CHAIR ACCREDITATIONS

AFRDI and BIFMA provide standards, testing and product certification for office furniture so that buyers can be sure their chosen chair is of high quality and fit for intended use.

AFRDI	GREENGUARD	BIFMA
AFRDI provides standards, testing and product certification across different levels of standards for furniture in the Australian market.	Greenguard certification helps buyers identify interior products and materials that have low chemical emissions during production.	BIFMA is an international body developing furniture safety, durability and sustainability standards that ensure product performance.

ERGO

Fully ergonomic black mesh back chair with seat slide and ratchet back, suitable for heavy duty use. Weight rating of 165kgs.

ERGO TASK		GREENGUARD	AFRDI
Seat Size	520 x 490mm		
Gas Height Range	450-540mm		
Optional Extras	Adjustable arms available as optional additional extra		
Weight Rating	165kg		



MOTION

Mesh back task chair with grey seat, donati-dopo weight sensitive mechanism, seat slide, lumbar cushion and 3D adjustable arms.

MMC BG		GREENGUARD	AFRDI
Seat Size	510 x 520mm		
Gas Height Range	440-530mm		
Finishes	Black mesh back, grey fabric seat and white frame		
Weight Rating	135kg		



HARTLEY TASK

Synchro mechanism with tension control, moulded foam seat, black mesh back and adjustable arms.

HARTLEY TASK		GREENGUARD	BIFMA
Seat Size	480 x 500mm		
Gas Height Range	440-520mm		
Finishes	Black mesh back, black fabric seat and black frame		
Weight Rating	110kg		



LUMINOUS

High back black mesh executive chair with synchro mechanism, adjustable arms and stylish white / grey frame.

LUMINOUS		GREENGUARD	BIFMA
Seat Size	480 x 545mm		
Gas Height Range	420-510mm		
Finishes	Black mesh back, black fabric seat and white / grey frame		
Weight Rating	135kg		



GESTURE

Mesh back task chair with grey seat, synchro-dynamic mechanism, seat slide and synchronised back rest and seat pan tilt.

GTC BK		GREENGUARD	BIFMA
Seat Size	480 x 470mm		
Gas Height Range	450-540mm		
Finishes	Black mesh back, grey fabric seat and black frame		
Weight Rating	130kg		



KAL

Black high mesh back with lumbar support, synchro mechanism with tension control and adjustable arms. Weight rating of 135kgs.

Seat Size	500 x 510mm	 
Gas Height Range	430-520mm	
Finishes	Black mesh back, black fabric seat and black frame	
Weight Rating	135kg	



EM300

Fully ergonomic mesh back, black fabric or black pu seat, optional extra polished aluminium base or adjustable arms also available.

Seat Size	490 x 440mm	Black Fabric
Gas Height Range	460-590mm	Black PU
Finishes	Available in black fabric or pu seat with black mesh back	
Weight Rating	110kg	



AM100

Fully ergonomic with curved black mesh back, black fabric seat and included adjustable arms.

Seat Size	470 x 490mm	Black
Gas Height Range	460-550mm	
Finishes	Black mesh back, black fabric seat and black frame	
Weight Rating	120kg	



ZOOM

Mesh back, foldable training and conference chair with optional extra foldable tablet arm available.

ZOOM and ZOOM TABLET		Black
Seat Size	490 x 460mm	 
Back Height	330mm	
Optional Extra	265 x 420mm Foldable tablet arm as additional extra	
Weight Rating	110kg	



AM200

Medium black mesh back with fabric seat, infinite lock tilt, adjustable arms, and polished aluminium base.

Seat Size	520 x 500mm	Black
Gas Height Range	420-520mm	
Finishes	Black mesh back, and fabric seat with aluminium base	
Weight Rating	120kg	



HARTLEY VISITOR

Black cantilever frame, adjustable arms and black mesh back visitor chair with comfortable padded fabric seat.

HARTLEY VISITOR		Black
Seat Size	510 x 480mm	 
Back Height	485mm	
Finishes	Black mesh back, and fabric seat with black frame	
Weight Rating	135kg	



WM600



Ideal meeting chair with polished aluminium base and arms, comfortable black mesh material.

Seat Size	510 x 420mm	Black
Gas Height Range	480-590mm	
Finishes	Black perforated mesh back and seat with polished aluminium frame	
Weight Rating	120kg	



VIVA

Stylish white polypropylene shell and white base with black PU seat pad.

VIVA		Black PU
Seat Size	455 x 430mm	 
Gas Height Range	425-515mm	
Finishes	Black PU seat with white frame	
Weight Rating	110kg	
Warranty	5 Years	



VESTA

Black mesh back chair with black fabric seat and arms, suitable for home office use.

Seat Size	460 x 460mm	Black
Gas Height Range	430-530mm	
Finishes	Black mesh back, and fabric seat and black frame	
Weight Rating	90kg	



RE100

Black plastic perforated back, single point lock with arms, suitable for home office use.

RE100		Black
Seat Size	510 x 500mm	
Gas Height Range	470-590mm	
Finishes	Black plastic back, and fabric seat and black frame	
Weight Rating	110kg	



VIENNA

Mesh back chair with arms, suitable for home office or light commercial use.

VIENNA		Black	Red
Seat Size	490 x 490mm	Blue	Lime
Gas Height Range	430-550mm	Silver	
Finishes	Black fabric seat with frame and choice of coloured mesh back		
Weight Rating	100kg		



CHAIR MAT

Dimpled chair mat for use on carpets, smooth chair mat for use on hard floors.

CHAIR MAT		Clear
MAT S - Small Dimpled	915mm x 1200mm x 2mm	
MAT L - Large Dimpled	1140mm x 1350mm x 2mm	
MAT SM S - Small Smooth	915mm x 1200mm x 2mm	
MAT SM L - Large Smooth	1140mm x 1350mm x 2mm	

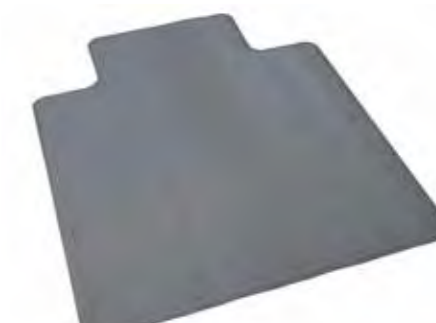

EC070CM

AFRDI level 6, fully ergonomic medium back fabric chair, injection moulded foam seat and back tilt with gas lift.

EC070CM		Black	
Seat Size	450 x 500mm	Navy	
Gas Height Range	470-600mm	Charcoal	
Optional Extras	Adjustable arms, polished aluminium base and drafting kit		
Weight Rating	120kg		



EC070BH

High back chair with gas lift, back tilt with injection moulded foam.

EC070BH		Black	
Seat Size	450 x 500mm	Navy	
Gas Height Range	470-600mm	Charcoal	
Optional Extras	Adjustable arms, polished aluminium base and drafting kit		
Weight Rating	120kg		



EC070BM

AFRDI level 6, medium back fabric chair with back tilt, gas lift and injection moulded foam seat.

EC070BM		Black	
Seat Size	450 x 500mm	Navy	
Gas Height Range	470-600mm	Charcoal	
Optional Extras	Adjustable arms, polished aluminium base and drafting kit		
Weight Rating	120kg		



EC070BM DRAFTING

Medium back drafting chair with back tilt, gas lift and injection moulded foam, adjustable arms available as optional extra.

EC070BM DRAFTING		Black	
Seat Size	450 x 500mm		
Gas Height Range	630-800mm		
Optional Extras	Adjustable arms		
Weight Rating	120kg		



EC070CH

High back chair with gas lift, back and seat tilt with injection moulded foam.

EC070CH		Black	
Seat Size	450 x 500mm	Navy	
Gas Height Range	470-600mm	Charcoal	
Optional Extras	Adjustable arms, polished aluminium base and drafting kit		
Weight Rating	120kg		



CHAIR ACCESSORIES



Adjustable Arms
Product Code: ADJ ARMS
Adjustable height arms with soft arm pad.



Polished Aluminium Base
Product Code: CH BASE
Modernise and upstyle your chair to look more up market with a polished aluminium base.



Drafting Kit
Product Code: DRAFTING KIT
Create a drafting chair from a compatible operator chair with this handy kit.

EG100CH

AFRDI level 6, fully ergonomic chair with back and seat tilt, gas lift and high back, for user up to 130kg.

EG100CH		Black	
Seat Size	520 x 480mm	Navy	
Gas Height Range	480-620mm	Charcoal	
Optional Extras	Adjustable arms, polished aluminium base and drafting kit		
Weight Rating	130kg		



SWIFT

High back black fabric operator chair, infinite tilt lock and polished aluminium spider base.

SWIFT BL		Black	
Seat Size	540 x 450mm		
Gas Height Range	510-590mm		
Optional Extras	Adjustable arms, polished aluminium base and drafting kit		
Weight Rating	130kg		



EG400

AFRDI level 6, fully ergonomic chair with back and seat tilt, square back, for user up to 130kg

EG400		Black	
Seat Size	520 x 480mm	Navy	
Gas Height Range	480-620mm	Charcoal	
Optional Extras	Adjustable arms, polished aluminium base and drafting kit		
Weight Rating	130kg		



ET20

Black fabric medium back chair with gas lift, back and seat tilt with injection moulded foam.

ET20		Black	
Seat Size	480 x 460mm		
Gas Height Range	420-530mm		
Optional Extras	Adjustable arms, polished aluminium base and drafting kit		
Weight Rating	100kg		



PO500

AFRDI level 6, fully ergonomic high back chair, extra large seat and back tilt with gas lift and heavy duty mechanism.

PO500		Black	
Seat Size	530 x 510mm	Navy	
Gas Height Range	490-590mm	Charcoal	
Optional Extras	Adjustable arms, polished aluminium base and drafting kit	Black PU	
Weight Rating	150kg		



CHAIR ACCESSORIES



Adjustable Arms
Product Code: ADJ ARMS
Adjustable height arms with soft arm pad.



Polished Aluminium Base
Product Code: CH BASE
Modernise and upstyle your chair to look more up market with a polished aluminium base.



Drafting Kit
Product Code: DRAFTING KIT
Create a drafting chair from a compatible operator chair with this handy kit.

PU300

Fully ergonomic soft black pu chair, ratchet back, seat slide, chrome base and adjustable arms.

PU300		Black PU
Seat Size	540 x 450mm	
Gas Height Range	510-590mm	
Finishes	Soft black PU seat and back with chrome spider base	
Weight Rating	130kg	



CL710

Soft black pu upholstery, 4 point tilt lock, high back executive chair with curved armrests.

CL710		Black PU
Seat Size	530 x 530mm	
Gas Height Range	460-550mm	
Finishes	Soft black PU seat and back with black spider base	
Weight Rating	120kg	



CL410

Soft black pu upholstery with fabric inlay, infinite tilt lock, curved arm rests and chrome base.

CL410		Black PU
Seat Size	540 x 500mm	
Gas Height Range	450-550mm	
Finishes	Soft black PU seat and back with chrome spider base	
Weight Rating	120kg	



CL820

Soft black pu upholstery, infinite tilt lock, curved polished aluminium arms and base.

CL820		Black PU
Seat Size	520 x 480mm	
Gas Height Range	420-490mm	
Finishes	Soft black PU seat and back with polished aluminium base	
Weight Rating	130kg	



CL610

Soft black pu upholstery, single point tilt lock, medium back with curved armrests.

CL610		Black PU
Seat Size	494 x 500mm	
Gas Height Range	450-580mm	
Finishes	Soft black PU seat and back with black spider base	
Weight Rating	120kg	



CHAIR MAT

Dimpled chair mat for use on carpets, smooth chair mat for use on hard floors.

CHAIR MAT		Clear
MAT S - Small Dimpled	915mm x 1200mm x 2mm	
MAT L - Large Dimpled	1140mm x 1350mm x 2mm	
MAT SM S - Small Smooth	915mm x 1200mm x 2mm	
MAT SM L - Large Smooth	1140mm x 1350mm x 2mm	

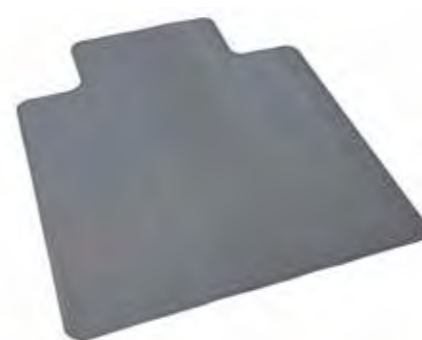

PELLE HIGH BACK

High back executive chair in black pu leather, seat and back tilt with multi-lock and polished aluminium 5 star spider base.

PHB BL		Black PU
Seat Size	500 x 560mm	
Gas Height Range	425-540mm	
Finishes	Soft black PU seat and back with polished aluminium base	
Weight Rating	130kg	



CL3000 HIGH BACK

High back slimline black pu leather executive chair with seat and back tilt, 3-position lock mechanism with anti shock.

CL3000 H		Black PU
Seat Size	505 x 510mm	
Gas Height Range	440-560mm	
Finishes	Soft black PU seat and back with polished aluminium spider base	
Weight Rating	120kg	



PELLE MEDIUM BACK

Medium back executive chair in black pu leather, seat and back tilt with multi-lock, polished aluminium 5 star spider base.

PMB BL		Black PU
Seat Size	500 x 560mm	
Gas Height Range	425-540mm	
Finishes	Soft black PU seat and back with polished aluminium base	
Weight Rating	130kg	



CL3000 MEDIUM BACK

Medium back slimline black pu leather executive chair with seat and back tilt, 3-position lock mechanism with anti shock.

CL3000 M		Black PU
Seat Size	505 x 510mm	
Gas Height Range	440-560mm	
Finishes	Soft black PU seat and back with polished aluminium spider base	
Weight Rating	120kg	



PELLE VISITOR CHAIR

Medium back executive visitor chair in black pu leather, with polished aluminium cantilever base.

PVM BL		Black PU
Seat Size	500 x 560mm	
Finishes	Soft black PU seat and back with polished aluminium cantilever base	
Weight Rating	130kg	



CL3000 VISITOR

Slimline executive visitor chair with soft black pu leather seat and back, chrome upholstered arms and cantilever base.

CL3000 V		Black PU
Seat Size	510 x 510mm	
Seat Height	460mm	
Finishes	Soft black PU seat and back with chrome cantilever base	
Weight Rating	120kg	



The executive chair range offers a combination of stylish looks, comfort and a choice of chair mechanisms to suit meeting, desk or task functions.

Ask your distributor for advice on the best chair to suit your needs.

PU605 MEDIUM BACK

Medium back black PU executive chair with infinite lock, polished aluminium base with chrome arms and frame.

PU605M		Black PU
Seat Size	485 x 460mm	
Gas Height Range	490-610mm	
Finishes	Black PU seat and back with chrome arms and polished aluminium base	
Weight Rating	120kg	



PU605 HIGH BACK

High back black PU executive chair with infinite lock, polished aluminium base with chrome arms and frame.

PU605H		Black PU
Seat Size	485 x 460mm	
Gas Height Range	490-610mm	
Finishes	Soft black PU seat and back with chrome arms and polished aluminium base	
Weight Rating	120kg	



PU900 MEDIUM BACK

Medium back with upholstered black pu, single point lock, polished aluminium base and arms.

PU900M		Black PU
Seat Size	520 x 435mm	
Gas Height Range	460-545mm	
Finishes	Soft black PU seat and back with polished aluminium base	
Weight Rating	120kg	



PU900 HIGH BACK

High back with upholstered black pu, single point lock, polished aluminium base and arms.

PU900H		Black PU
Seat Size	415 x 500mm	
Gas Height Range	460-550mm	
Finishes	Soft black PU seat and back with polished aluminium base	
Weight Rating	120kg	



LUJO MEDIUM BACK



Medium back executive chair with built-in lumbar support, high grade synchro mechanism with flared arm rest design.

LUJO-MB RB		Blue
Seat Size	475 x 475mm	 
Gas Height Range	450-540mm	
Finishes	Royal blue fabric with black fabric to underside of arm rest and polished aluminium base	
Weight Rating	120kg	

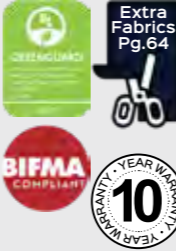
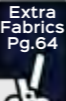

HARTLEY VISITOR

Black cantilever frame, adjustable arms and black mesh back visitor chair with comfortable padded fabric seat.

HARTLEY VISITOR		Black PU
Seat Size	510 x 480mm	   
Back Height	485mm	
Finishes	Black mesh back, and fabric seat with black frame	
Weight Rating	135kg	



NOVA

Visitor or meeting chair with fabric seat and back, black powdercoated frame, stackable and linking.

NOVA		Navy	Charcoal
Seat Size	444 x 448mm	 	
Back Height	338mm		
Features	Stackable and linking SGS tested		
Finishes	Navy, black or charcoal fabric		
Weight Rating	110kg		



WMCC

Visitor chair with cantilever chrome base and arms, comfortable black mesh material and fabric seat.

WMCC		Black PU
Seat Size	470 x 470mm	 
Seat Height	440mm	
Back Height	500mm	
Finishes	Black mesh back and fabric seat	
Weight Rating	120kg	



WMBVK

Visitor chair with comfortable mesh back and fabric seat. Chrome frame with curved plastic arm rests.

WMBVK		Black PU
Seat Size	480 x 480mm	 
Back Height	480mm	
Finishes	Black mesh back with fabric seat	
Weight Rating	110kg	



WVF100 BL

Comfortable black fabric chair with chrome sled base, modern and stylish design.

WVF100 BL		Black PU
Seat Size	435 x 450mm	
Back Height	390mm	
Finishes	Black padded fabric seat and back with chrome sled frame	
Weight Rating	120kg	



PMVBK

Black mesh back chair with plastic seat and back, stackable and linking chrome sled base and frame.

PMVBK		Black PU
Seat Size	460 x 455mm	
Back Height	300mm	
Finishes	Black plastic back and seat with chrome sled base	
Weight Rating	110kg	



MAUI

Polypropylene chair with white and slate grey frame. Grey fabric seat cover included.

MAUI		Chair Finish	White
Seat Size	465 x 450mm	Seat Covers	White
Back Height	395mm		
Accreditation	BIFMA and GreenGuard Gold approved - made from 100% recyclable materials		
Weight Rating	135kg		



ALOHA

White elastic polypropylene breakout or meeting chair with silver legs. Seat covers extra.

ALOHA		Chair Finish	White
Seat Size	430 x 430mm	Seat Covers	White
Back Height	370mm		
Optional Extras	Fabric seat covers ASP BK - Black ASP BU - Light Blue		
Weight Rating	120kg		



COMFO

Visitor or meeting chair with black pu leather seat and back, chrome cantilever base and padded curved arm rests.

COMFO		Chair Finish	Black PU
Seat Size	510 x 490mm		
Back Height	510mm		
Finishes	Black pu leather seat and back with chrome frame and base		
Weight Rating	110kg		



LEO

Plastic hospitality chair suitable for indoor or outdoor use, aluminium legs, black or white plastic.

LEO		Chair Finish	White
Seat Size	420 x 410mm	Seat Covers	Black
Back Height	420mm		
Finishes	White or black plastic with aluminium legs - Suitable for indoor or outdoor use		
Weight Rating	100kg		



TAURUS

Indoor hospitality chair with chrome legs and back cut out feature, black or white plastic.

TAURUS		Chair Finish	White
Seat Size	435 x 430mm	Seat Covers	Black
Back Height	345mm		
Finishes	Plastic shell in white or black with chrome frame		
Weight Rating	110kg		



FERNANDO

Sylish black pu seat and back with chrome frame, cut out feature in back of chair.

FERNANDO		Chair Finish	Black PU
Seat Size	425 x 420mm		
Back Height	480mm		
Finishes	Black pu leather seat and back with chrome frame		
Weight Rating	90kg		



VIRGO

Timber leg breakout chair with polypropylene shell, grey with black fabric seat pad or black with grey fabric seat pad.

VIRGO		Chair Finish	Grey
Seat Size	440 x 440mm	Seat Covers	Black
Back Height	355mm		
Finishes	Polypropylene plastic shell with soft upholstered seat pad		
Weight Rating	110kg		



VIVID

Large polypropylene shell seat with powdercoated steel sled base with nylon glides. Available in black or white finishes.

VIVID		Chair Finish	White
Seat Size	455 x 470mm	Seat Covers	Black
Back Height	390mm		
Back Width	410mm		
Finishes	White or black plastic		
Weight Rating	120kg		



FRAME CHAIR

Perforated back rest and polypropylene seat stacking visitor or conference chair, with linking feature and solid rod base.

FRAME		Chair Finish	Black
Seat Size	455 x 420mm	Seat Covers	Black
Back Height	370mm		
Finishes	Black		
Certification	BIFMA Tested ANS/ BIFMA X5.1		
Weight Rating	120kg		



ARIES BAR STOOL

Stylish black metal curved frame with polypropylene plastic seat pan available in black, grey or green finishes.

ARIES ST		Chair Finish	Black
Seat Size	455 x 545mm	Seat Covers	Green
Seat Height	760mm		
Overall Height	853mm		
Finishes	Black frame with black, grey or green seat pan		
Weight Rating	110kg		



TAURUS BAR STOOL

Indoor hospitality stool with chrome base and polypropylene plastic curved seat with cut out back feature.

TAURUS STOOL		Chair Finish	Black
Seat Size	435 x 455mm	Seat Covers	White
Seat Height	750mm		
Overall Height	1050mm		
Finishes	Chrome frame with black or white seat		
Weight Rating	110kg		



VIRGO BAR STOOL

Modern bar stool with oak coloured frame, available with curved polypropylene plastic seat pan in black, grey or green.

VIRGO ST		Chair Finish	Black
Seat Size	475 x 475mm	Seat Covers	Green
Seat Height	770mm		
Overall Height	820mm		
Finishes	Oak coloured frame with black, grey or green seat		
Weight Rating	110kg		



P100

Polypropylene plastic stacking chair in black.

Seat Size	450 x 370mm	Black
Back Height	405mm	
Finishes	Black polypropylene shell with black powdercoated frame	3 YEAR WARRANTY
Weight Rating	130kg	



DS DESK STOOL

400mm round seat desk stool, easy to clean black pu material with black spider base.

Seat Size	400 x 400mm	Black PU
Gas Height Range	450-570mm	
Finishes	Black pu material seat with black spider base	3 YEAR WARRANTY
Weight Rating	100kg	



V100

Comfortable black fabric visitor chair with black frame, stackable.

Seat Size	450 x 450mm	Black
Back Height	300mm	
Finishes	Black fabric upholstered seat and back with black metal frame	3 YEAR WARRANTY
Weight Rating	120kg	



DS COUNTER STOOL

400mm round seat counter stool with chrome drafting ring, easy to clean black pu material and black spider base.

Seat Size	400 x 400mm	Black PU
Gas Height Range	650-870mm	
Finishes	Black pu material seat, black spider base with chrome drafting ring	3 YEAR WARRANTY
Weight Rating	100kg	



LAB CHAIR

Laboratory chair with moulded polyurethane contoured waterfall seat pan and back rest with seat and back tilt.

Seat Size	470 x 435mm	Black	NEW
Gas Height Range	420-540mm		
Finishes	Black back rest and seat with black nylon base	5 YEAR WARRANTY	
Weight Rating	110kg		



LAB STOOL

Laboratory stool with moulded polyurethane contoured waterfall seat pan, tilting back rest with adjustable drafting ring.

Seat Size	460 x 440mm	Black	NEW
Gas Height Range	640-850mm		
Finishes	Black back rest and seat with chrome plated drafting ring	5 YEAR WARRANTY	
Weight Rating	110kg		



WIMBLETON

Black plastic seat and back, chrome sled base, linking and stackable with range of optional extra's also available.

Seat Size	425 x 430mm	Black Plastic
Back Height	245mm	
Optional Extras	Wimbleton chair available with arms, or tablet arm, back and seat pad	3 YEAR WARRANTY
Weight Rating	120kg	



ZOLA

Black plastic seat and curved back, with chrome stackable frame.

Seat Size	440 x 460mm	Black Plastic
Back Height	200mm	
Finishes	Black plastic back and seat with chrome frame	3 YEAR WARRANTY
Weight Rating	100kg	



WIMBLETON CHAIR OPTIONAL EXTRAS



WITH ARMS TABLET ARM



SEAT AND BACK PAD CUSTOM UPHOLSTERY

Z TROLLEY

Trolley available for PMVBK, ZOLA, ZING, WIMBLETON and FRAME chairs.

Finishes	Black with white plastic wheels	Black
Warranty	3 Years	
		3 YEAR WARRANTY



ZING

Large black plastic back and seat with chrome frame, linking and stackable.

Seat Size	465 x 430mm	Black Plastic
Back Height	370mm	
Finishes	Black plastic back and seat with chrome frame as standard. Seat and back pad available in range of colours	BIFMA COMPLIANT 3 YEAR WARRANTY
Weight Rating	120kg	



PIPPEE

Polypropylene plastic stacking chair, holds up to 150kg under intended use. Available in 3 colours with high luster shine.

Seat Size	400 x 380mm	White Grey
Back Height	410mm	
Finishes	White, grey and green	Green
Weight Rating	150kg	
		3 YEAR WARRANTY



Chair and Screen Upholstery

For a wider colour selection than our standard express range, we can upholster certain products in a range of extended house fabrics, or your fabric of choice.

CHAIR OPTIONS

- EM300
- ECO70CM
- EG100
- PO500
- MOTION
- GESTURE
- LUMINOUS
- ERGO
- HARTLEY TASK
- HARTLEY VISITOR
- KAL
- ZOOM
- WMCC
- WMBK
- WIMBLEDON (Back and Seat Pad)
- CONNECT OTTOMAN
- MARS OTTOMANS
- ZING (Back and Seat Pad)



SCREEN OPTIONS

- SCREEN
(Fabric Top Half of Screen Panel)
- INFINITY FABRIC SCREENS
- FREESTANDING ACOUSTIC SCREENS

HOUSE FABRICS



Lead Times and Additional Charges May Apply



Welcome to the improved presentation range.

Not only has the quality of the product been improved but so has the packaging, assisting with damage free storage and transportation. This helps us offer up to a 25 year warranty on selected presentation products.

The range now has extended options offering porcelain whiteboards for a longer life and superior clean, and glassboards for those users looking for an impressive, sharp presentation.

GLASSBOARD

Super clear 4mm toughened glassboard with magnetic surface. Galvanised steel backing with 25mm chrome fittings and clear pen tray.

GB96, GB129, GB159, GB1512, GB189, GB1812, GB2112 or GB2412		White
Sizes	900 x 600mm, 1200 x 900mm, 1500 x 900mm, 1500 x 1200mm, 1800 x 900mm, 1800 x 1200mm, 2100 x 1200mm and 2400 x 1200mm	
Depth	15mm	
Features	Compatible with any whiteboard markers or liquid chalk markers (not included).	



LECTERN

Heavy duty lectern with angled top shelf for presentations and second shelf for storage in black powdercoated finish.

LCT12 BL		Black
Frame Size	445 x 450mm	
Height	1200mm	
Top Shelf Size	600mm W x 400mm D	
Second Shelf Size	550mm W x 260mm D	
Features	Detachable adjustable battery powered LED light	



STANDARD WHITEBOARD

Wall mounted aluminium framed magnetic whiteboard, pen tray, concealed corner fixing, acrylic polyester resin.

W96, W129, W1212, W159, W1512, W189, W1812, W219, W2112 or W2412		White
Sizes	900 x 600mm, 1200 x 900mm, 1200 x 1200mm, 1500 x 900mm, 1500 x 1200mm, 1800 x 900mm, 1800 x 1200mm, 2100 x 900mm, 2100 x 1200mm and 2400 x 1200mm	
Depth	15mm	



PORCELAIN WHITEBOARD

Wall mounted porcelain whiteboard available in a range of sizes.

PWB96, PWB129, PWB1212, PWB159, PWB1512, PWB189, PWB1812, PWB2112, PWB2412, PWB3012 or PWB3612		White
Sizes	900 x 600mm, 1200 x 900mm, 1200 x 1200mm, 1500 x 900mm, 1500 x 1200mm, 1800 x 900mm, 1800 x 1200mm, 2100 x 1200mm, 2400 x 1200mm, 3000 x 1200mm and 3600 x 1200mm	
Depth	15mm	



PINBOARD

Wall mounted pinboard with concealed corner wall fixings, in blue or grey fabric

PIN96, PIN129, PIN1212, PIN159, PIN1512, PIN189, PIN1812 or PIN2412		Blue
Sizes	900 x 600mm, 1200 x 900mm, 1200 x 1200mm, 1500 x 900mm, 1500 x 1200mm, 1800 x 900mm, 1800 x 1200mm and 2400 x 1200mm	
Depth	15mm	
Finish	Blue or grey fabric with silver frame	



ECO PANEL SLIDE ON SCREEN

Slide on divider screen with pinnable surface in polyester eco friendly fibre.

EPS60 BK		Black
Size	650 x 300mm	
Thickness	27mm	
Compatibility	Compatible with deluxe infinity, span, worker and manager ranges	



ECO PANEL SCREEN

Desk mounted screen with screw plate fixing in pinnable surface made from polyester eco friendly fibre.

EPS098 BK, EPS119 BK or EPS149 BK		Black
Size	890 x 285mm, 1190 x 285mm or 1490 x 285mm	
Thickness	27mm	
Compatibility	Compatible with infinity, span, worker and manager ranges	



CHAIR MAT

Dimpled chair mat for use on carpets, smooth chair mat for use on hard floors.

CHAIR MAT		Clear
MAT S - Small Dimpled	915mm x 1200mm x 2mm	
MAT L - Large Dimpled	1140mm x 1350mm x 2mm	
MAT SM S - Small Smooth	915mm x 1200mm x 2mm	
MAT SM L - Large Smooth	1140mm x 1350mm x 2mm	

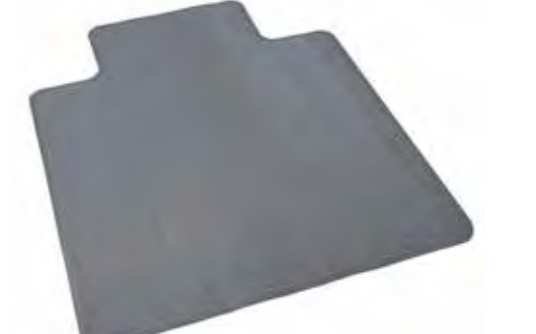

MOBILE WHITEBOARD

Double sided pivoting mobile whiteboard with pen tray.

M129, M159, M1512, M189 or M1812		White
Sizes	1200 x 900mm, 1500 x 900mm, 1500 x 1200mm, 1800 x 900mm and 1800 x 1200mm	
Frame Depth	15mm	
Overall Depth	550mm	
Warranty	8 Years	



MOBILE PORCELAIN WHITEBOARD

Double sided pivoting mobile porcelain whiteboard with pen tray.

PMW129, PMW1512 or PMW1812		White
Sizes	1200 x 900mm, 1500 x 900mm, 1500 x 1200mm, 1800 x 900mm and 1800 x 1200mm	
Frame Depth	15mm	
Overall Depth	550mm	
Warranty	25 Years	



CORKBOARD

Composite corkboard with aluminium frame and concealed corner wall fixings, suitable for pins or stickers.

C96, C129, C1212, C159, C1512, C189, C1812 or C2412		Cork
Sizes	900 x 600mm, 1200 x 900mm, 1200 x 1200mm, 1500 x 900mm, 1500 x 1200mm, 1800 x 900mm, 1800 x 1200mm and 2400 x 1200mm	
Depth	15mm	
Finish	Composite cork	



ACOUSTIC SCREEN

Free standing dividing office panels, in 50mm thick, pinnable fabric with black pvc edging and silver freestanding feet.

A1515, A1518, A1815 or A1818		Blue
Width x Height	1500 x 1500mm, 1500 x 1800mm, 1800 x 1500mm and 1800 x 1800mm	
Thickness	50mm	
Finishes	Blue or grey fabric	
Warranty	5 Years	



UTILITY TROLLEY

Utility trolley with 3 tiers of storage space and castor wheels for ease of movement. Perfect to be moved around any office.

TR3		Ironstone
Width	800mm	
Depth	600mm	
Height	900mm	
Finish	Ironstone shelves with black frame	
Weight Rating	100kg	



CORNER LOZENGE

Converts desk and return to a corner workstation by adding diagonal for user to sit at, to fit 25mm or 33mm deep tops.

LOZENGE25 or LOZENGE33		Graphite
Size	250mm W x 480mm L	
Depth	25mm or 33mm D	
Compatibility	Melamine desk and return with 25mm or 33mm D top	
Finish	Graphite	





GO STEEL SLIMLINE MOBILE PEDESTAL

Slimline, lockable mobile pedestal ideal for smaller workstations to allow for maximum under desk leg room.

GSP3 WC or GSP3 BL		<input type="checkbox"/> White China	<input type="checkbox"/> Black
Size	300 x 472mm		
Height	610mm		
Features	Flush drawer front which stores foolscap files back to front, ball bearing runners and fifth wheel for stability		
Optional Extra	Keyed alike locks available		



GO STEEL MOBILE PEDESTAL

Lockable mobile pedestal with full extension ball bearing runners and flush drawer front.

GMP3 WC, GMP3 BS, GMP3 PS or GMP3 GR		<input type="checkbox"/> White China	<input type="checkbox"/> Black Satin
Size	460 x 472mm	<input type="checkbox"/> Precious Silver	<input type="checkbox"/> Graphite Ripple
Height	610mm		
Features	Flush drawer front which stores foolscap files side to side, ball bearing runners and fifth wheel for stability		
Optional Extra	Keyed alike locks available		



ETERNITY SLIMLINE MOBILE PEDESTAL

Slimline powdercoated steel mobile pedestal with 2 personal drawers and 1 file drawer, fifth wheel for stability and anti-tilt.

EMP3 WB		<input type="checkbox"/> White / Black
Width	300mm	
Depth	535mm	
Height	580mm	
Warranty	10 Years	



GO STEEL MOBILE CADDY

Flush front fully lockable mobile pedestal and tambour door section with centre shelf, ideal for hot desks or as desk return.

GCAD L (Left) or GCAD R (Right)		<input type="checkbox"/> White	<input type="checkbox"/> Black
Size	1050 x 460mm		
Height	570mm		
Orientation	GCAD L - Tambour door on left hand side or GCAD R - Tambour door on right hand side		
Warranty	10 Years		



GO STEEL FILING CABINET

Heavy duty filing cabinets, fully riveted with ball bearing runners and 40kg weight capacity per drawer.

GFCA2, GFCA3 or GFCA3		<input type="checkbox"/> White China	<input type="checkbox"/> Black Ripple
Size	460mm W x 620mm D	<input type="checkbox"/> Silver Grey	<input type="checkbox"/> Graphite Ripple
Height	2 drawer - 705mm 3 drawer - 1016mm 4 drawer - 1321mm		
Finishes	White china, black ripple, silver grey or graphite ripple		



GO STEEL LATERAL FILING CABINET

Heavy duty lateral filing cabinets, riveted construction for extra strength, anti-tilt locking, 2 rows of folders per drawer.

GLF2, GLF3 OR GLF4		<input type="checkbox"/> White China	<input type="checkbox"/> Black Satin
Size	900mm W x 473mm D		
Height	2 drawer - 705mm 3 drawer - 1016mm 4 drawer - 1321mm		
Finishes	White china or black satin		
Warranty	10 Years		



OFFICE LOCKER

Space efficient storage system for offices. 6 lockers per unit featuring a removable shelf and mail slot on door.

OFL138 WC		
Size	800 x 486mm	White China
Height	1375mm	
Features	6 lockable individual compartments with name holder fitted to each door. 4 easy adjustable levelling feet, unit finished in white china powdercoat.	



BOLTLESS SHELVING

Easy to assemble boltless shelving unit with heavy duty metal shelves, available in 2 widths.

GV189 and GV1812		
Size	914mm W or 1220mm W	Silver Grey
Depth	457mm	
Height	1830mm	
Features	50kg weight rating per shelf	
Warranty	10 Years	



GO STEEL CUPBOARD

GO steel flush lock cupboard tested to british standards, supplied assembled or flat pack with 2 sets of keys.

GCA10, GCA18 and GCA20			
Size	910mm W x 450mm D	White China	Silver Grey
Height	GCA10 - 2 shelves - 1015mm GCA18 - 3 shelves - 1830mm GCA20 - 4 shelves - 2000mm		
Optional Extra	GCWSG Shelf and coat rail as optional extra for use in cupboard		



SHELVING UNIT

Flat packed, clip together easy to assemble shelving unit which includes 5 adjustable shelves in silver grey finish.

GSC9422		
Size	910mm W x 400mm D	Silver Grey
Height	2200mm	
Features	40kg weight rating per shelf	
Finishes	Silver grey	
Warranty	10 Years	



GO STEEL WARDROBE

Lockable GO steel swing door wardrobe featuring hanging rail and 3 shelves creating 4 separate storage compartments.

GWA18		
Size	910mm W x 450mm D	Silver Grey
Height	1830mm	
Features	Hanging rail and 4 separate shelf compartments	
Warranty	10 Years	



MESH DOOR CUPBOARD

Foldable 2 door metal mesh security cupboard, supplied flat pack with 5 adjustable shelves and padlock latch.

208-F2DMSC		
Size	900mm W x 450mm D	Silver Grey with Yellow Doors
Height	1850mm	
Finishes	Silver grey cupboard with yellow metal mesh doors and padlock latch on front (padlock not included)	
Warranty	10 Years	



TAMBOUR DOOR CUPBOARD

Tambour door cupboards for storage with easy glide track and magnetic anti slam rail which keeps doors closed. Fully riveted for extra strength, locking with 2 keys (master series), optional extra shelves and accessories available.

GTD109, GTD129, GTD199, GTD1012, GTD1212 or GTD1912			
Width	900mm or 1200mm	White China	Black
Depth	473mm		
Height	1016mm, 1200mm or 1981mm		
Optional Extras	Sold as tambour door cupboard unit only, shelves sold separately		



SLOTTED SHELF AND DIVIDERS

Slotted shelf for use in tambour door cupboards to accept separate slotted shelf dividers, reinforced shelf for durability.

GG09 SLOT, GG12 SLOT SHELF and GS7D Dividers			
Shelf	GG09SLOT - for 900mm wide unit GG12SLOT - for 1200mm wide unit	White China	Black
Dividers	GS7D - pack of 5 slotted shelf dividers sold separately		
Features	Rear support for dividers and reinforced shelf for heavy duty durability and stability		



PLANTER BOX

Planter box with 3 holes for plants and incorporated drip tray, use on top of tambour door cupboards or lateral filing cabinets.

PB900 and PB1200			
Width	900mm or 1200mm	White China	Black
Depth	473mm		
Height	230mm		
Features	Fully assembled with incorporated drip tray, space for 3 x 200mm plant pots (plants and pots not included)		



PLAIN SHELF

Adjustable static plain shelf for use in tambour door cupboards, available in 2 different widths and finishes.

GTD900 and GTD1200			
Width	GTD900 - for 900mm wide unit GTD1200 - for 1200mm wide unit	White China	Black
Depth	470mm		
Height	30mm		
Finishes	White china or black		
Warranty	10 Years		



Space efficient method of bulk storage with base mounted false floor, easy to level with adjustable feet. Mobile shelving unit available in 2 different widths and 4, 6 or 8 bay configuration. Add on extra double bays or additional shelves in both widths at anytime, to extend size and storage capacity of mobile shelving unit. White powdercoated finish to unit for modern style with charcoal grey base.



4 BAY MOBILE SHELVING

RMS4900 and RMS41200	
Width	980 or 1280mm
Length	2670mm
Height	2150mm
Shelf Capacity	110kg shelf capacity
Warranty	10 Years

6 BAY MOBILE SHELVING

RMS6900 and RMS61200	
Width	980 or 1280mm
Length	3560mm
Height	2150mm
Shelf Capacity	110kg shelf capacity
Warranty	10 Years

8 BAY MOBILE SHELVING

RMS8900 and RMS81200	
Width	980 or 1280mm
Length	4450mm
Height	2150mm
Shelf Capacity	110kg shelf capacity
Warranty	10 Years



Melamine lockers offer a personal storage solution that blends into your space. Use in both office and educational applications. Each locker includes 2 x keys per lock.



Various internal features in each compartment. E1 rated moisture resistant melamine and MDF doors with soft close hinges, and adjustable levelling feet to each unit.

SINGLE DOOR LOCKER

WRML-305/1	
Width	305mm
Depth x Height	455mm x 1850mm
Finishes	MR Melamine / MDF
Features	1 x Hat shelf and 1 x hanging rail per compartment. Includes 2 x keys per lock

2 DOOR LOCKER

WRML-305/2	
Width	305mm
Depth x Height	455mm x 1850mm
Finishes	MR Melamine / MDF
Features	1 x Hanging rail per compartment. Includes 2 x keys per lock

3 DOOR LOCKER

WRML-305/3	
Width	305mm
Depth x Height	455mm x 1850mm
Finishes	MR Melamine / MDF
Features	Empty compartment. Includes 2 x keys per lock

4 DOOR LOCKER

WRML-305/4	
Width	305mm
Depth x Height	455mm x 1850mm
Finishes	MR Melamine / MDF
Features	Empty compartment. Includes 2 x keys per lock

STEP DOOR LOCKER

SDWRML380/2	
Width	380mm
Depth x Height	455mm x 1850mm
Finishes	MR Melamine / MDF
Features	1 x Hanging rail per compartment. Includes 2 x keys per lock



STEEL LOCKERS

Steel lockers offer an easy way to store personal belongings.

Choose from single, 2 or 4 door options to suit your requirements, or a step locker which provides 2 hanging spaces.



SINGLE DOOR LOCKER	2 DOOR LOCKER	4 DOOR LOCKER	STEP LOCKER
GL305/1 and GL380/1	GL305/2 and GL380/2	GL305/4 and GL380/4	STEP LOCKER
Width: 305mm or 380mm	Width: 305mm or 380mm	Width: 305mm or 380mm	Width: 380mm
Depth x Height: 455mm x 1830mm	Depth x Height: 455mm x 1830mm	Depth x Height: 455mm x 1830mm	Depth x Height: 455mm x 1830mm
Finishes: 305mm - White china or silver grey 380mm - Silver grey only	Finishes: 305mm - White china or silver grey 380mm - Silver grey only	Finishes: 305mm - White china or silver grey 380mm - Silver grey only	Finishes: Silver grey only
Features: Riveted construction for extra strength, vented doors for ventilation, fitted with hat shelf and coat rail storage	Features: Riveted construction for extra strength, vented doors for ventilation, fitted with coat hook in each compartment	Features: Riveted construction for extra strength, vented doors for ventilation, full length stiffeners fitted to each door for rigidity	Features: Riveted construction for extra strength, vented doors for ventilation, allows 2 hanging spaces per locker, hanging rail included



LOCKER ACCESSORIES

LOCKER STAND

Locker stand to bank 2 or 3 lockers, suitable for 305mm wide lockers only. Silver powdercoated frame and black levelling feet.

SB2305 and SB3305		Silver Grey
Width	SB2305 - 610mm W for 2 lockers SB3305 - 915mm W for 3 lockers	10 Year Warranty
Depth x Height	455mm x 150mm	
Features	Raise lockers off floor to allow for easy cleaning underneath and extra stability when joined together	



SEAT AND STAND

Seat and stand to suit bank of 2 or 3 lockers, suitable for 305mm wide lockers, powdercoated frame and oak style seat.

S+S2305 and S+S3305		Silver Grey
Width	S+S2305 - 610mm W for 2 lockers S+S3305 - 915mm W for 3 lockers	10 Year Warranty
Depth x Height	700mm x 350mm	
Features	Raise lockers off floor and add a bench seat in front for use in locker rooms, schools, gyms and other applications	



BENCH SEAT

Single sided bench seat with light oak style modified wood slats, silver coated frame and black levelling feet.

BS1000		Silver Grey
Width	1000mm	10 Year Warranty
Depth	360mm	
Height	400mm	
Features	Sturdy bench seat for use in locker rooms, schools, gyms and other applications	



SLOPING TOP

Sloping top in silver grey for use with either a single locker or bank of 3 lockers. Suitable for 305mm wide lockers only.

G12830 and G32830		Silver Grey
Width	G12830 - for single 305mm wide locker G32830 - for bank of 3 x 305mm wide lockers	10 Year Warranty
Height	270mm	
Features	Neat and easy to clean 30° degree sloping top for single locker or bank of 3 lockers, suitable for 305mm wide lockers only	



DIGITAL LOCK

Digital keypad code lock to be used with steel or melamine lockers as optional extra. Public or private lock programming.

DIGITAL LOCK		Black
Finish	Black	1 Year Warranty
Features	Public or private lock code programming for one time or permanent use Use with both steel or melamine lockers *batteries not included*	



BUTTERFLY LOCK

Butterfly lock for use with all GO Steel lockers to enable padlock facility on doors (padlock not included).

BUTTERFLY LOCK		Chrome
Padlock Requirements	Suitable for use with padlock shafts 6mm-8mm and shackle 25mm-30mm	10 Year Warranty
Finish	Chrome	
Features	Supplied fitted to lockers when ordered simultaneously	
Warranty	10 Years	





WORKSTATIONS - FURNITURE - SEATING - STORAGE - ACCESSORIES
WWW.EPICOFFICEFURNITURE.COM.AU

