

# SpacePod.

## Product Specifications



# SpacePod.

When silence is golden and privacy is paramount, the SpacePod offers the perfect escape from the noisy office floor.

Insulated by layers of sheet metal, birch plywood, recycled acoustic foam and acoustic felt, stepping inside feels like walking into a professional recording booth. Not only are you shielded from outside noise, but the internal acoustic treatments provide for crystal-clear, echo-free audio quality on phone and video calls. Mid to high range soundwaves are damped by the acoustic felt while rounded floor and ceiling joinery helps address the build-up of low, bass sounds.

Available to use within hours of construction, the SpacePod includes a gas lift stool, tabletop, LED lighting, air-ventilation system, USB A/C ports and a 240V electrical power outlet.

Placed in the middle of an open plan office or tucked away next to the overbooked meeting rooms, the SpacePod is the best way to incorporate private spaces without breaking the budget.

## Key Features

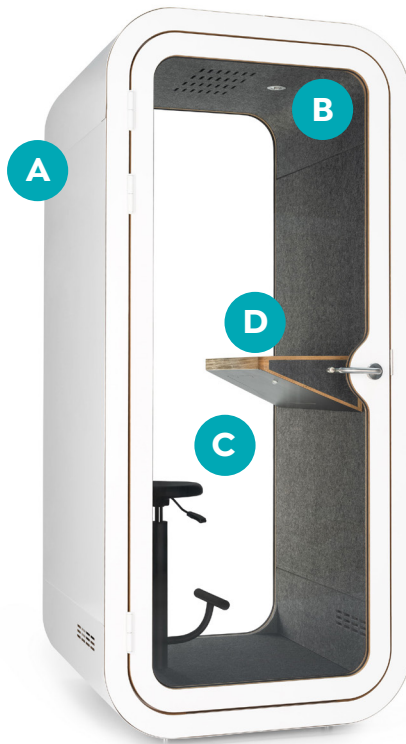

### A. Solid Construction

Sheet metal, birch plywood, recycled acoustic foam and acoustic felt.

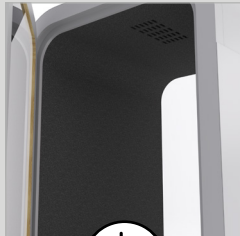

### B. Noise Cancellation

Superior speech level reduction of 30.99 dB.

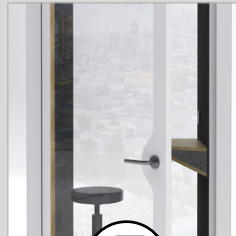

### C. Glass Door & Rear

Sound control laminated glass door and rear wall.

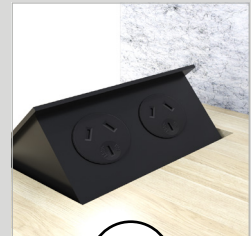

### D. Power Options

240 volt power socket and USB charging.

# SpacePod.

## In Detail



### Air Ventilation

More than 1m<sup>3</sup>.minute standard adjustable ventilation options.



### Internal Lighting

LED lighting with brightness adjustment options.



### Quality Materials

Sheet metal, birch plywood, recycled acoustic foam and acoustic felt.



### Anti Static

Anti-static and stain resistant low loop pile carpet on interior floor.

### Glass Door & Rear

Sound control laminated glass door and rear wall.

**Noise Cancellation**  
Superior speech level reduction of 30.99 dB.

### Anti-Static Materials

Anti-static and stain resistant low loop pile carpet on interior floor.

### Internal Lighting

Adjustable LED lighting.

### Air Ventilation

More than 1m<sup>3</sup> per minute standard adjustable ventilation options.

### Power Options

240 volt power socket and USB charging.

### Solid Construction

Sheet metal, birch plywood, recycled acoustic foam and acoustic felt.

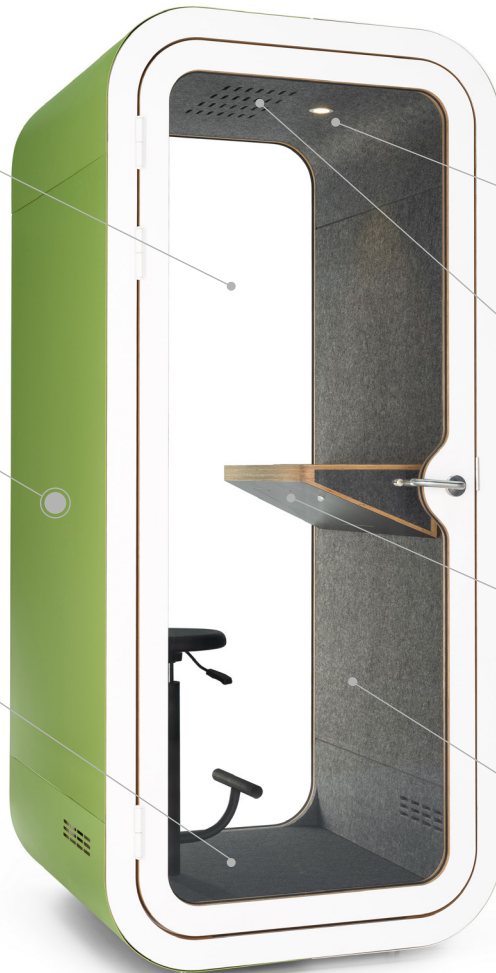

\* Refer to page 5 for Ratings & Certifications details.

# SpacePod.

## Optional Upgrades



Single Spacepod with custom exterior colour



Single Spacepod with custom interior colour



Single Spacepod with custom seat upholstery colour

## Dimension Specifications

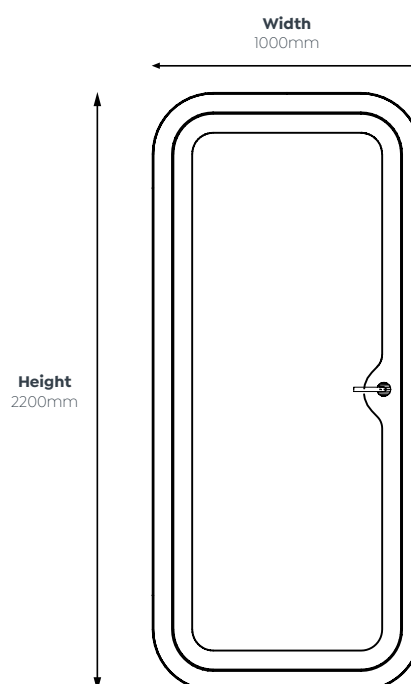
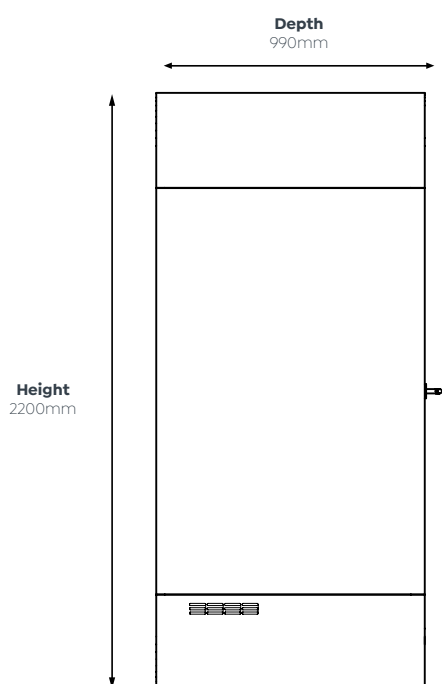

# SpacePod.

## 2 User & 4 User Optional **Upgrades**



2 User Spacepod  
with custom colour



4 User Spacepod  
with custom colour

## Dimension **Specifications**

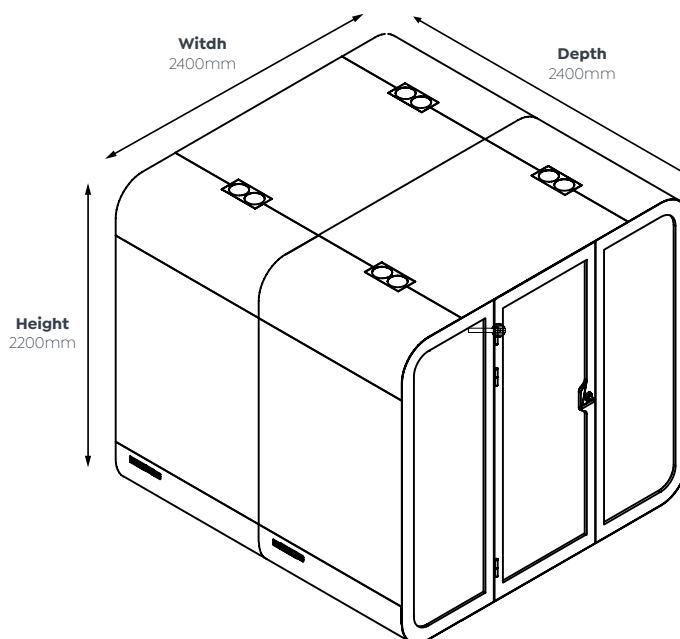
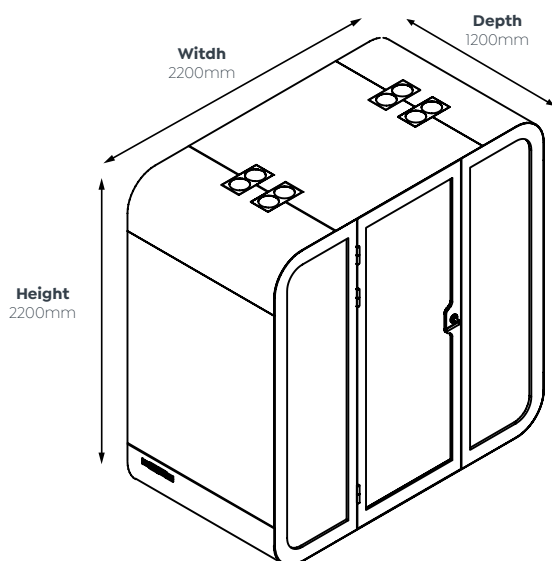

# SpacePod.

## Standard Colours - In Stock



Frame and table  
-White HPL standard



Exterior- RAL 9016  
White Standard

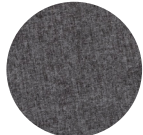

Sofa Upholstery  
standard

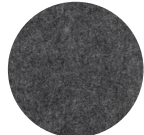

Interior PET felt  
standard



Carpet  
standard



Exterior- RAL 9005  
Black Standard



Frame and table  
-Black HPL  
standard

## Colour Options - Exterior colour options



RAL 9016 White  
Standard



RAL 7035  
Light Grey

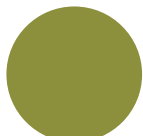

Khaki  
Green



RAL 2012  
Salmon Orange



RAL 3020  
Traffic Red



RAL 5013  
Cobalt Blue



RAL 9005  
Black Standard

## Colour Options - Frame and table



Frame and table  
-White HPL standard



F0927  
Formica



F0803  
Formica



F2962  
Formica



F1238  
Formica



F0806  
Formica



Frame and table  
-Black HPL standard

## Colour Options - Sofa Upholstery

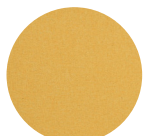

HE512-05



HE512-10



HE512-06

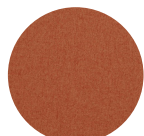

HE512-20

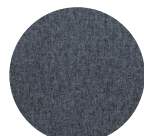

HE512-11

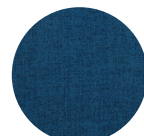

HE512-09



HE512-13

## Colour Options - Interior - PET acoustic felt

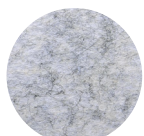

PC2033



FG2125

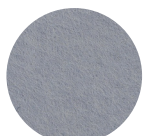

814

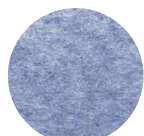

PP2028

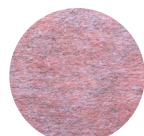

FP2016

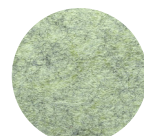

FPE2120

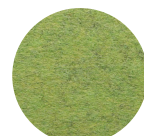

PG2039

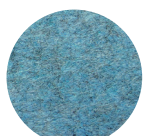

FB2021



PO2019

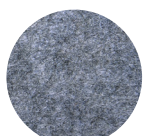

FG2032

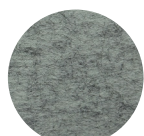

FE2121

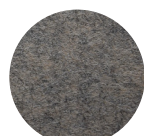

FC2110



PC2022

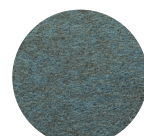

PB2037



PG2018

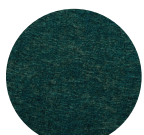

PB2025

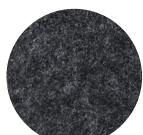

817

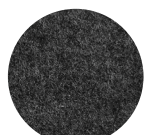

A028

# SpacePod.

## Cheat Sheet Quick Guide

### Standard Features

#### Exterior

Powder coated steel

#### Glass (door & rear)

Sound control laminated glass

#### Frame and table

Laminate on birch plywood with varnish trim

#### Solid walls, roof and floor

A sandwich element of sheet metal, birch plywood, recycled acoustic foam and acoustic felt. An anti-static and stain resistant low loop pile carpet for interior floor.

### Measurements

#### Exterior (height, width, depth)

2200 × 1000 × 990mm

#### Interior (height, width, depth)

2000 × 800 × 898mm

#### Door (height, width)

2046 × 846mm

#### Table (width, depth, height)

650 × 300 × 160mm

Electric sockets are integrated on the table

### Air Ventilation

#### Air Ventilation Ventilation rate:

More than 1m<sup>3</sup>/minute standard  
Available Higher ventilation options

### Power consumption

#### Power consumption standard

3.24W while in use

0.75W standby power consumption

#### Input:

110-240VAC, 10A, 50/60Hz

### Outlets

#### Regular table:

Power socket + USB-A

### Output values

#### Output VAC (power socket):

100-240 VAC, 8 A, 50-60 Hz

#### Output USB charging:

USB Type A socket (Type C option)

Maximum combined output 18 W

### Acoustic performance

For Speech Level Reduction (DSA), and Noise Isolation Class (NIC), third party test reports are available on request

### Packaging and transportation

**Net weight (kg):** 336

**Gross weight (kg):** 428

**Packaging size:** 2270×830×1130mm

### Upgrade Options

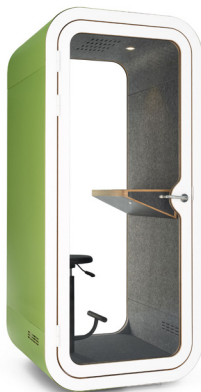

Single Spacepod with custom exterior colour



Single Spacepod with custom interior colour



Single Spacepod with custom frame and table colour



Single Spacepod with custom seat upholstery colour

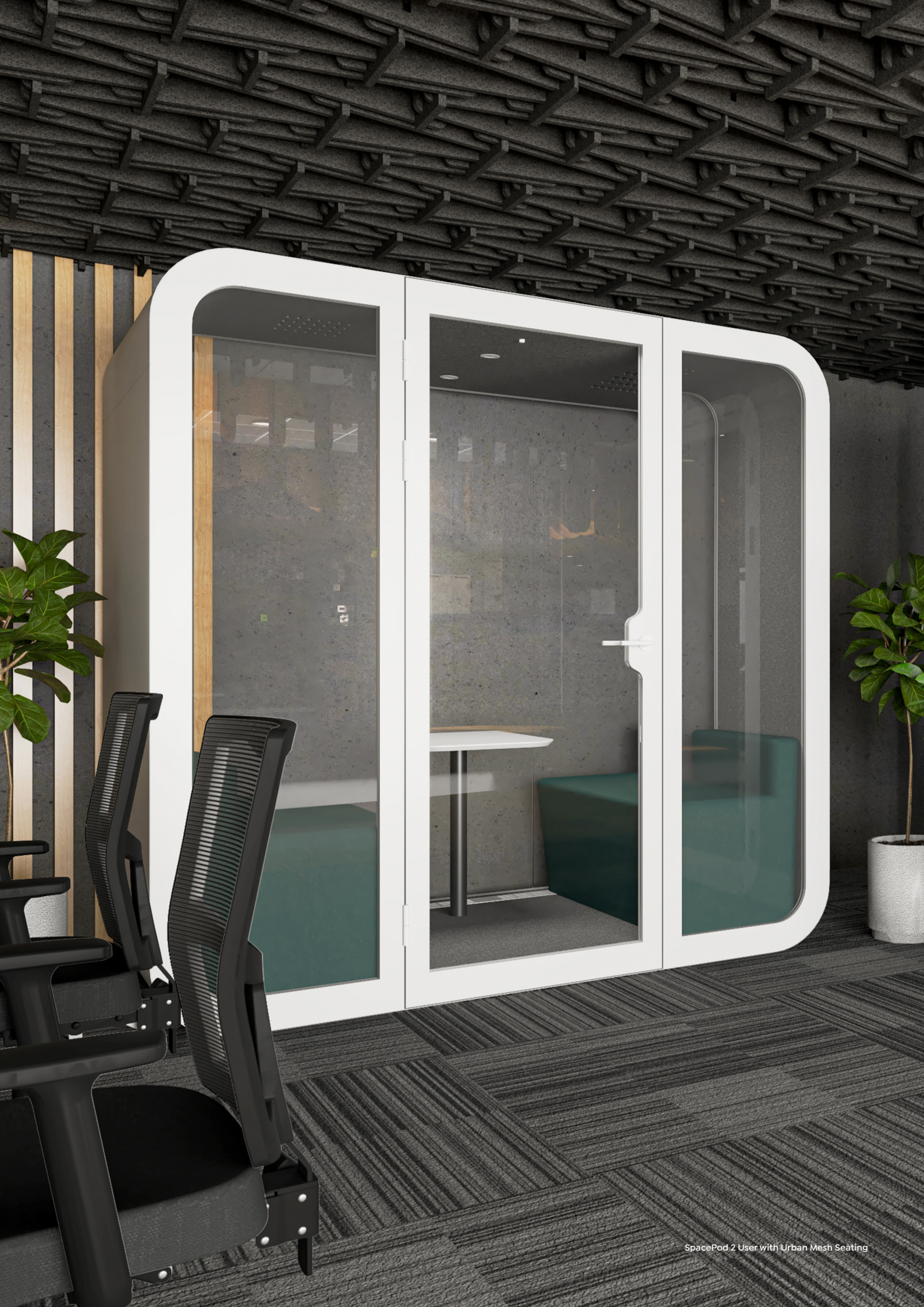





SpacePod Single User, MotionOffice Otto, Plantation Desking with Radius18 Screens and Axis Mobile Caddy

# Additional Options.

## Desking



**QuickStand Desk**  
Height Adjustable  
Single Sided Desk



**Agile Fixed**  
Single Sided Desk



**Agile Fixed**  
90° Workspace



**Agile Fixed**  
Desk with Return



**Agile Fixed**  
2 User 90° Workspace



**Agile Winder**  
Height Adjustable  
2 User Double Sided Desk



**Agile Winder**  
Height Adjustable  
Single Sided Desk



**Agile Electric 2 Column**  
Height Adjustable  
Single Sided Desk



**Agile Electric 2 Column**  
Height Adjustable  
90° Workspace



**Agile Electric 2 Column**  
Height Adjustable  
2 User 90° Workspace



**Agile+ Electric 3 Column**  
Height Adjustable  
Single Sided Desk



**Agile+ Electric 3 Column**  
Height Adjustable  
90° Workspace



**Agile+ Electric 3 Column**  
Height Adjustable  
120° Workspace



**Agile+ Electric 3 Column**  
Height Adjustable  
2 User Double Sided Desk



**Agile+ Electric 3 Column**  
Height Adjustable  
Triple 120° Workstation



**Agile+ Round Legs 3C**  
Electric Height Adjustable  
Single Sided Desk



**Agile+ Round Legs 3C**  
Electric Height Adjustable  
Single Sided Desk



**Agile+ Round Legs 3C**  
Electric Height Adjustable  
Single Sided Desk



**Agile+ Round Legs 3C**  
Electric Height Adjustable  
Single Sided Desk



**Agile+ Round Legs 3C**  
Electric Height Adjustable  
Triple 120° Workstation



**Anvil**  
Single Sided Desk  
with Studio50 Screen



**Anvil**  
Single Sided  
90° Workspace



**Anvil**  
2 User Double Sided  
90° Workspace



**Anvil**  
2 User Single Sided Desk  
with Studio50 Screen



**Axis**  
Single Sided Desk  
with Modesty



**Axis**  
Single Sided Desk  
with Return



**Axis**  
2 User Single Sided Desk  
with Studio50 Screen



**EkoSystem**  
Single Sided Desk



**EkoSystem**  
Single Sided Desk with Return



**EkoSystem**  
90° Workstation

