



# Grove Sofa.

Product **Specifications**



# Grove Sofa.

The Grove Sofa offers a modern, modular approach to commercial seating, fitting into any contemporary commercial space.

Featuring soft curves and edges, it incorporates current design trends to create a visually appealing and inviting atmosphere. The system includes matching plywood modular tables and planters, adding natural wood accents to enhance any setting. Built for durability, the Grove Range uses heavy-duty commercial fabric options suitable for 24-hour use, ensuring long-lasting performance and comfort. With 90° and 60° corners, this sofa system accommodates various plan layouts, providing flexibility for any environment. Available in both double-sided and single-sided configurations, the Grove Range meets specific sizing and collaboration needs.

The Grove Sofa combines style, functionality, and durability, making it an ideal choice for dynamic commercial spaces.

## Key Features



Disclaimer: Plants not included with purchase.

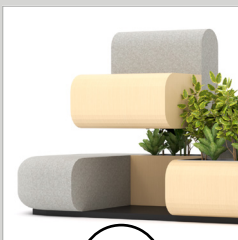

### 1. Modern, Modular Design

A sleek modular design able to adapt to fill spaces perfectly in style.

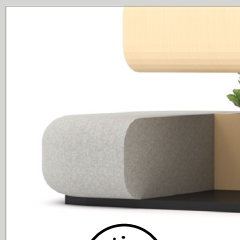

### 2. Soft Curves and Edges

Grove's soft curves reflect a modern design, enhancing contemporary office aesthetics with a soft & inviting look.



### 3. Matching Plywood Modular Tables and Planters

Featuring built-in planters and tables with stainless inserts, adding functionality and natural timber accents to offices spaces.



### 4. Commercial Sprung Seat and Back

The Grove sofa is built with a commercial spring set and back design for 24 hour use and long-lasting comfort.

# Grove Sofa.

## Dimension & Specifications

### Standard Features

Modern, modular design - A sleek, modular design, perfect for enhancing contemporary commercial spaces with flexibility and style.

Soft Curves and Edges -Grove's soft curves reflect a modern design, enhancing contemporary office aesthetics with a soft look.

Matching Plywood Modular Tables and Planters - Featuring built-in plywood planters and tables, adding functionality and natural accents to modern office spaces.

Heavy-duty commercial fabric options for 24-hour use - The Grove uses heavy-duty commercial fabric designed for 24-hour use, ensuring durability and long-lasting comfort.

90° and 60° corners

10 year warranty

Available in double-sided and single-sided configurations.

Accommodates various plan layouts for flexibility to fit any space.

### Finishes

Timber Finish: Oak

### In Stock Fabric Options



## Grove Sofa Modules

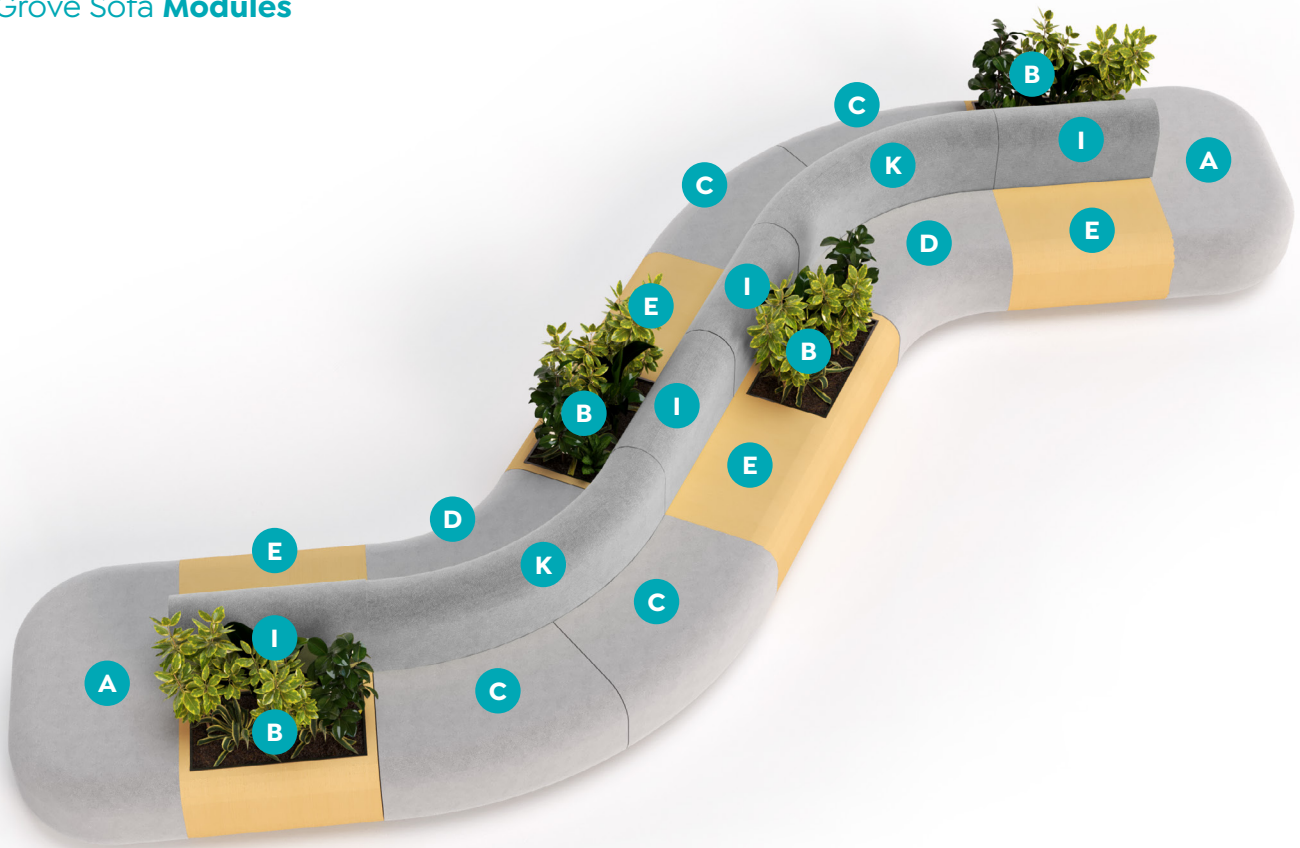

# Grove Sofa.

## Grove Sofa Modules



# Grove Sofa.

## Grove Sofa Full Module Specifications

### Grove Sofa module seat height & foot detail

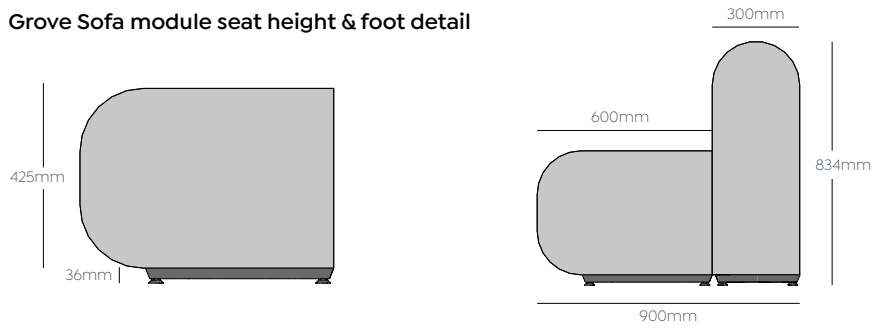

A

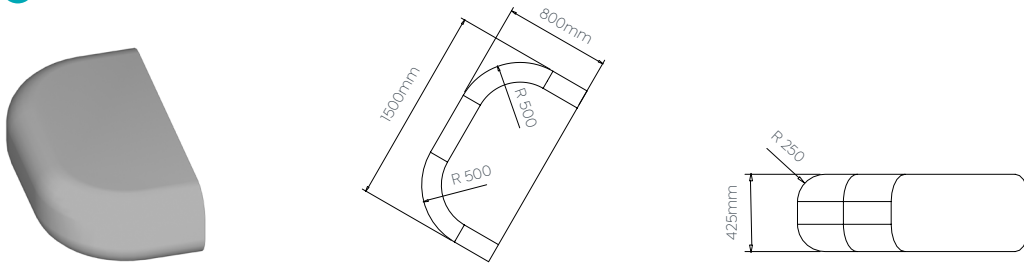

B

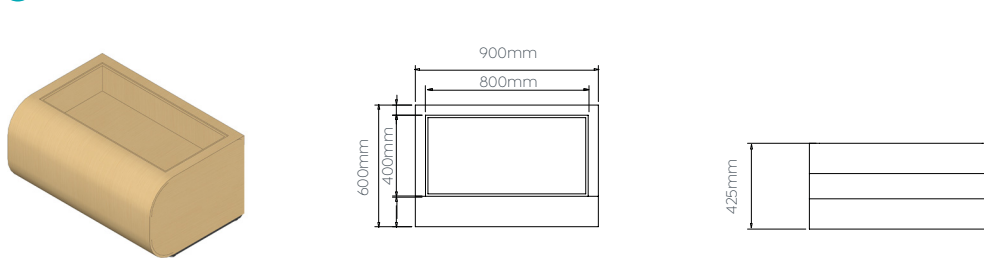

C

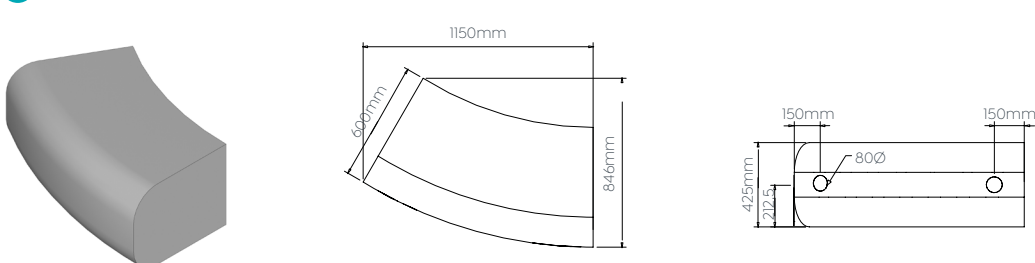



# Grove Sofa.

## Grove Sofa Full Module Specifications

D

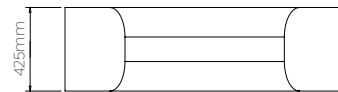
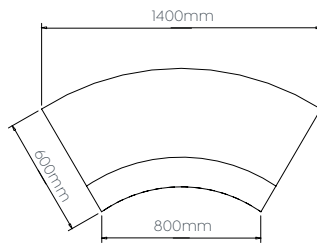
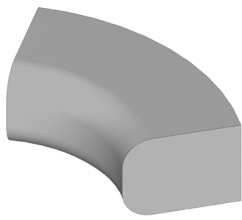

E

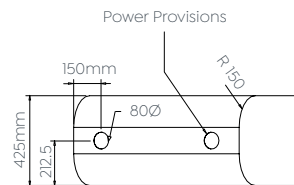
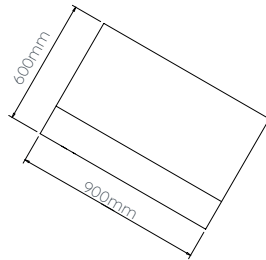

F

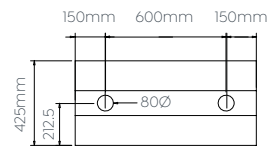
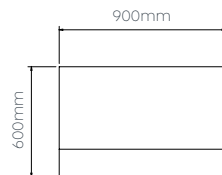
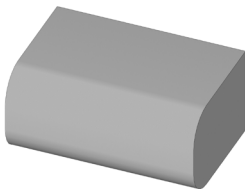

G

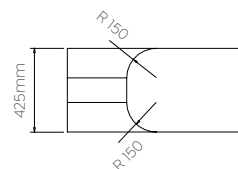
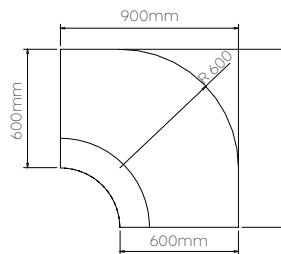
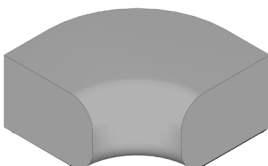

# Grove Sofa.

## Grove Sofa Full Module Specifications

H

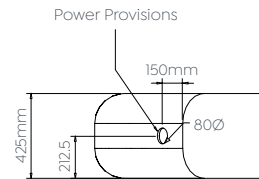
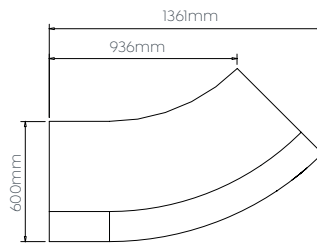
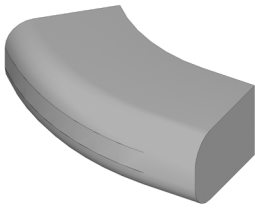

I

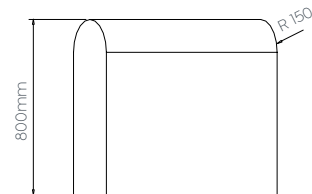
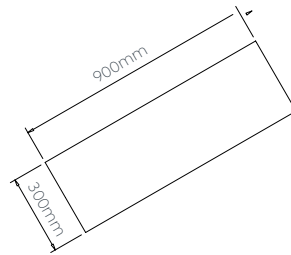
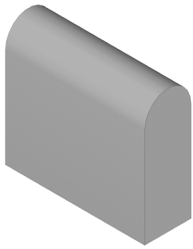

J

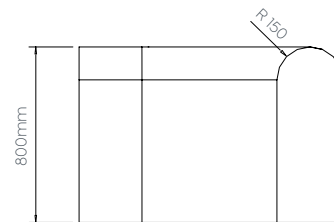
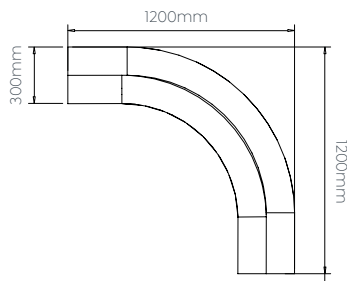
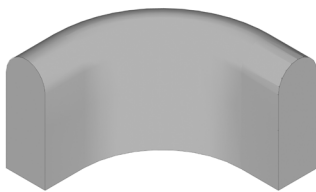

K

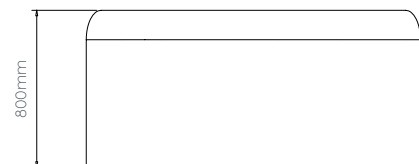
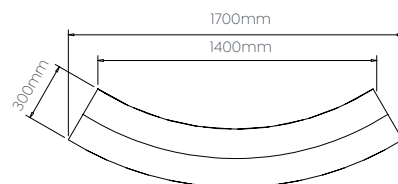
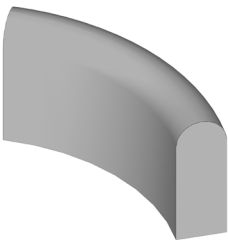

# Grove Sofa.

## Example Configurations

01.

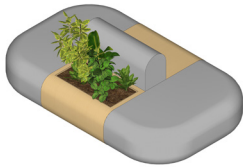

02.

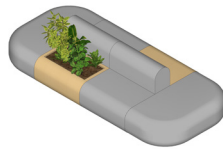

03.

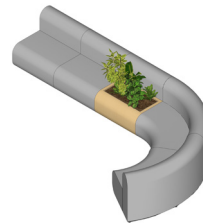

04.

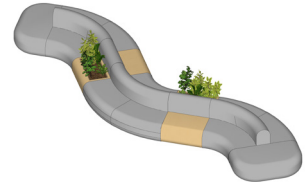

05.

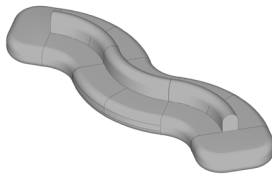

06.

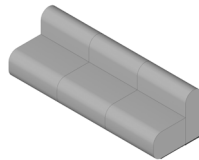

07.

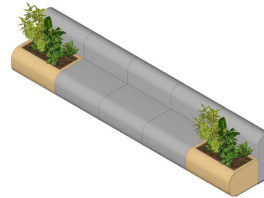

08.

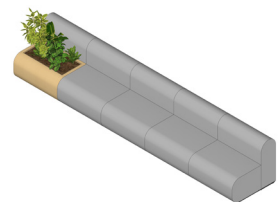

09.

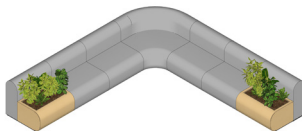

10.

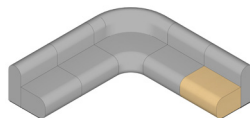

11.

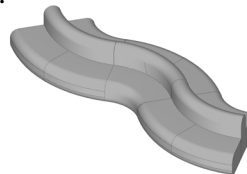

12.

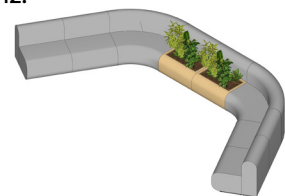

13.

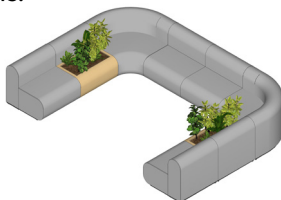

14.

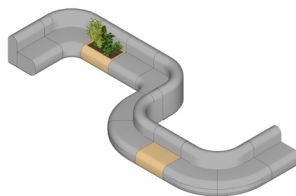

15.



16.

